



Journal of Chemistry and Technologies

pISSN 2663-2934 (Print), ISSN 2663-2942 (Online).

journal homepage: <http://chemistry.dnu.dp.ua>

editorial e-mail: chem.dnu@gmail.com

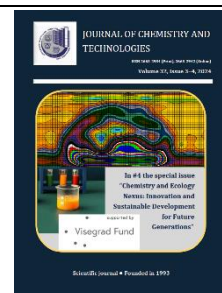

UDC 665.11

OLEOCHEMICAL PRODUCTS IN SYNTHESIS TECHNOLOGIES OF ECO-FRIENDLY POLYMERS

Oleh V. Chervakov*, Denys O. Chervakov, Kostiantyn M. Sukhyi, Vitalii Yu. Kuzminskyi, Kostiantyn Ye. Varlan, Elena A. Belyanovskaya, Yevhenii P. Levchenko, Mykhailo S. Yurchik
 Ukrainian State University of Science and Technologies, Scientific and Educational Institute "Ukrainian State Chemical and Technological University" 8 Nauky Ave., Dnipro, 49005, Ukraine

Received 4 September 2024; accepted 20 December 2024; available online 25 January 2025

Abstract

Promising directions of synthesis from renewable vegetable oil raw materials of monomeric and oligomeric oleochemical products are considered: modified triglycerides as ingredients of special-purpose polymer compositions; fatty alcohols, esters and amides of fatty acids as surfactants in detergents, cosmetics, paints, pharmaceuticals, as ecological fuel; polyols and hydroxyl-containing oligomers for the synthesis of polyurethane, polyesteramide, polyurethaneamide binders and coatings with anti-corrosion and antimicrobial properties. The synthesis routes of fatty acid amides, in particular hydroxyl-containing ones with a functionality of 2 or more, as starting compounds for promising polyesteramides are considered in detail. The strategy of synthesis from vegetable oils of saturated polyols with primary hydroxyl groups as promising components for environmentally friendly paint and varnish compositions is considered. Data on the synthesis and properties of polyurethaneamides, polyesteramides and metal-containing derivatives based on them are presented. For each product type an analysis was made of the state of development of a particular technology, as well as future prospects and existing barriers to their development. The possibility of using metal-containing polymers to create biodegradable materials and coatings with hydrophobic properties and antimicrobial activity was shown.

Keywords: fatty acid amides; "green" chemistry; metal-containing biopolymers; oleochemistry; polyesteramides, polyester polyols; polyurethane amides; vegetable oil.

ОЛЕОХІМІЧНІ ПРОДУКТИ В ТЕХНОЛОГІЯХ СИНТЕЗУ ЕКОЛОГІЧНИХ ПОЛІМЕРІВ

Олег В. Черваков, Денис О. Черваков, Костянтин М. Сухий, Віталій Ю. Кузьмінський, Костянтин Є. Варлан, Олена А. Беляновська, Євгеній П. Левченко, Михайло С. Юрчик
 Український державний університет науки і технологій, Науково-навчальний інститут «Український державний хіміко-технологічний університет», пр. Науки, 8, Дніпро, 49005, Україна

Анотація

Розглянуто перспективні напрямки синтезу з рослинної олійної сировини мономерних та олігомерних олеохімічних продуктів (діолів, поліефірних поліолів, діетаноламідних похідних жирних кислот) і полімерів на основі олеохімічних речовин: поліуретанів, поліефірамідів, поліуретанамідів і металохімічних полімерів на їх основі. Для кожного виду продукту проведено аналіз стану розвитку конкретної технології, а також майбутні перспективи та існуючі перепони для їх розвитку. Показано можливість використання металовмісних полімерів для створення біорозкладних матеріалів і покриттів з гідрофобними властивостями та антимікробною активністю.

Ключові слова: амідні жирних кислот; «зелена» хімія; металовмісні біополімери; олеохімія; поліестераміди, поліестерполіоли; поліуретанаміди; рослинна олія

*Corresponding author: e-mail: dchervakov@ukr.net

© 2024 Oles Honchar Dnipro National University;

doi: 10.15421/jchemtech.v32i4.309194

Introduction

Recently, there has been a rapid increase in publications devoted to the possibility of using renewable materials in "green" technologies for the synthesis of low- and high-molecular compounds (lubricants and plasticizers for elastic and frost-resistant polymer materials [1], reagents for hydrometallurgy [2; 3]) and promising functionalized polymer materials: binders and foams [4; 5], polymer composite materials [6; 7], binding electrode materials for electrochemical devices [8], etc. Principally, this interest is conditioned to the limited reserves of traditional fossil hydrocarbon feedstocks, in particular oil and gas.

As a renewable raw material, of undoubted interest are oleochemicals – products of triglyceride chemical processing raw materials, in particular oils of vegetable origin (sunflower, soybean, linseed, hemp, castor, palm, etc.), and fats of animal origin (beef, fish oil and etc.), non-traditional fatty raw materials obtained from diatom algae [9] or products of microbiological origin (for example, fungi and yeast) [10]. Technological development has made it possible to convert vegetable oils directly into many industrial products with the prefix "bio": biosolvents, biodetergents, biolubricants, bioplastics and biosurfactants [11], which have a relatively low cost and have the ability to biodegrade.

The problems of effective and comprehensive processing of renewable feedstocks are located within the purview of "green" chemistry with its efforts being directed to processing, utilization or reduction of environmentally unsafe by-products and waste products generated by chemical, food and other industries. The main goal of research in this direction conducted is to ensure

environmental safety or to reduce wasteful and unsafe factors to acceptable values.

It should be noted that existing methods of oleochemical synthesis (of fatty acids and their derivatives, glycerol, etc.) are sometimes considered as "inelegant" because of serious concerns associated with the generation of waste and high costs of synthesis and isolation target products. Moreover, use of oleochemicals does not always ensure the necessary level of physicochemical, mechanical and other properties desired for the commercial product.

In this review article, we provide an analysis of promising, in our opinion, technologies for processing fatty raw materials of plant origin into monomeric oleochemical products, as well as the synthesis methods of commercially available oleochemical-based polyesteramides (PEA), polyurethanamides (PUA) and polyurethanes (PU) and materials with the practically useful properties on their basis: paints, coatings and polymer composite materials (PCM).

Analysis of the literature data

Triglycerides and oleo-chemical products (oleochemicals) on their basis

Triglycerides TG (the main component of unrefined (unpurified) raw fat materials of plant, animal or other origin) – on the one hand, are the most accessible raw materials characterized by low price, non-toxicity, biodegradability, on the other hand, they have a unique chemical structure determined by the presence of R – chains of saturated and/or unsaturated fatty acids, which can be converted into epoxy, hydroxyl, ester or other functional groups depending on their field of application by fairly simple chemical transformations (see Fig. 1 and 2).

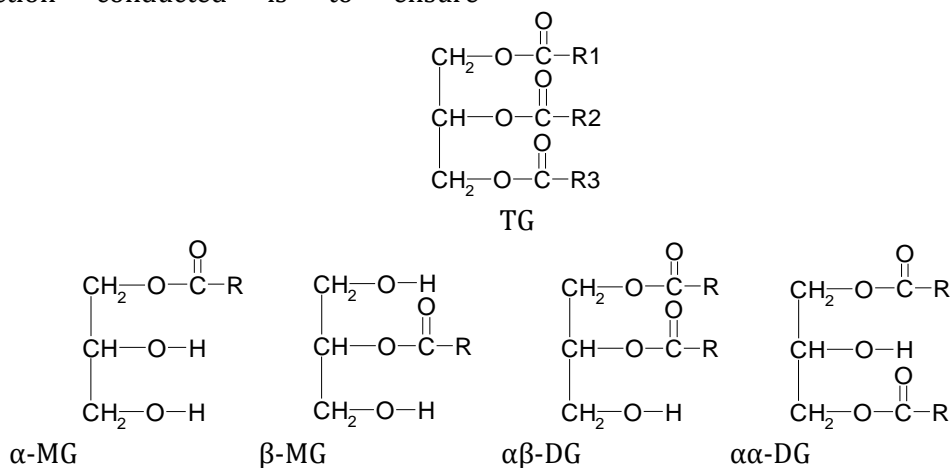

Fig. 1. Structural formulas of triglyceride TG, mono- (α -MG, β -MG) and diglycerides ($\alpha\beta$ -DG, $\alpha\alpha$ -DG), where $-C(O)R$ are saturated and/or unsaturated fatty acid chains

TG, DG, and MG or products of their chemical transformations (derivatives of fatty acids) can be used as raw materials for the production of low and high molecular weight polymers and different materials on their basis: paints, varnishes, coating systems of special application [12], polymer composite materials [1] and may be novel ingredients and binders for high energetic propellant for the new military or space technique [13; 14].

Synthesis of MG and DG from TG has long been known and is widely used to obtain the corresponding substances, used as ingredients by the food industry [15].

It should be noted that in coatings and polymer composite materials manufacturing, fats are used

both in neat and modified forms, trying to achieve the necessary chemical structure that ensures attainment of desired technological and operational properties by polymer materials.

So, natural fats like sunflower oil (Fig. 2) and other functionalized oils, in particular, epoxidized soybean (EO) and castor (RC) oils, are fairly widely used for the synthesis of urethane-alkyd binders, epoxy resins, polyurethanes, polyesteramides. It is possible to obtain fat-based non-toxic and biodegradable materials that are already widely used in various industries: automotive (as lubricants) [16], civil engineering (in the manufacture of structural materials) [17; 18], and in the production of coatings [19].

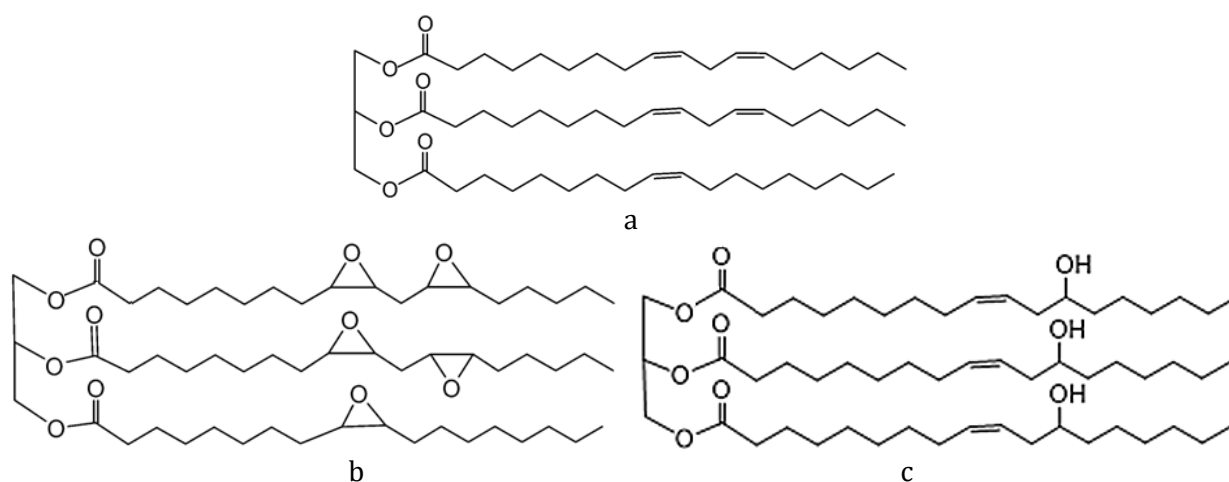

Fig. 2. Common structures of sunflower (a), epoxidized soybean (b) and castor (c) oils

Methods of epoxidized oil production and its use as "green" plasticizer and stabilizer in polyvinylchloride (PVC) processing are known [20], this type of additives is widely used in food packaging films and toys.

At the same time, the presence of reactive epoxide, hydroxyl and/or unsaturated groups in the oils shown in Fig. 2 allows them to be considered as a readily available high quality raw material source for the production of monomeric and oligomeric products, polymeric materials.

In this regard, it is important to develop methods for the synthesis of oleochemical compounds (analogues of petrochemical products) from fatty raw materials of vegetable or animal origin. At the same time, vegetable oils can play a vital role in the development of new valuable alternatives to some petrochemical products that ensure the sustainable development of society [21].

Currently, oleochemical industry is focusing on inexpensive and renewable raw materials for the

production of oleochemical products with high biodegradability, low toxicity and low environmental impact (with a reduced carbon footprint).

From a practical point of view, a more promising raw material for the synthesis of oleochemicals is the use of nonedible vegetable oils (NEVOs). Composition and properties of some NEVOs are described in detail in a review [22]:

According to the authors of [22], researchers should be interested in popularizing the cultivation and production of NEVOs using low fertility lands or wastelands. Such an approach will undoubtedly make it possible to solve global and critical food problems.

Oleochemicals made from edible and non-edible vegetable oils are synthesized using various chemical processes, including hydrolysis, alcoholics (transesterification), saponification, and hydrogenation [23], as shown below.

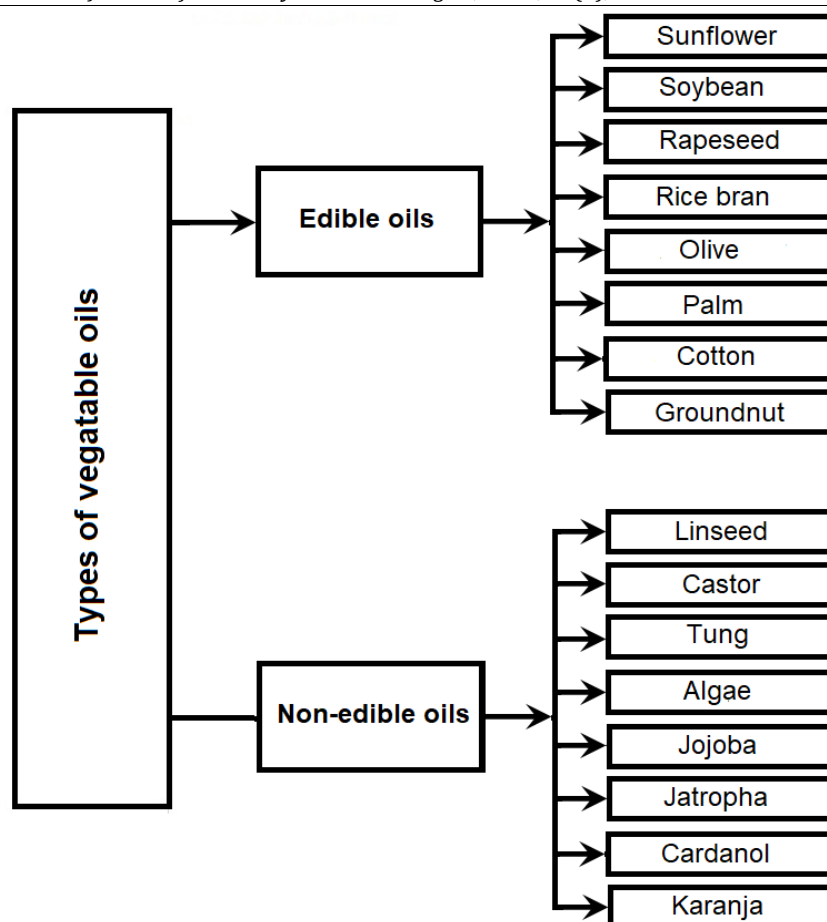

Fig. 3. Examples of some representatives of edible and nonedible vegetable oils

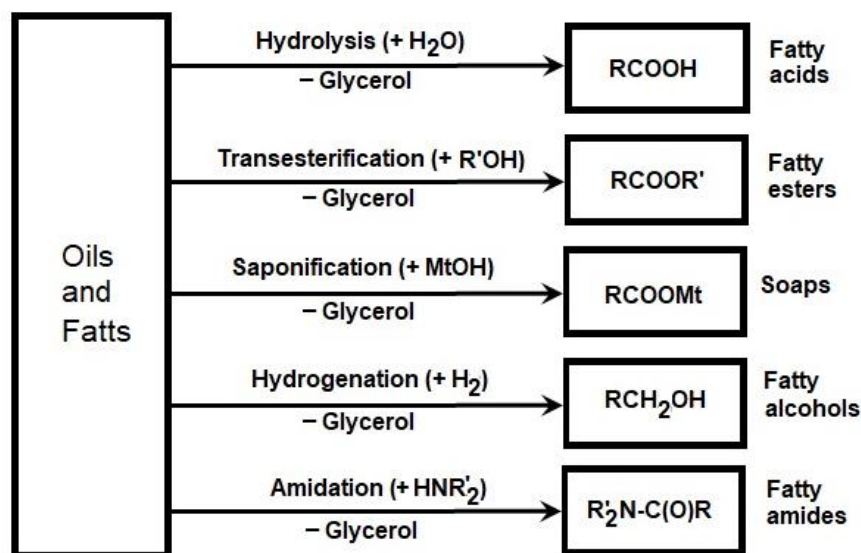

Fig. 4. Important processes in oleochemical manufacturing

The most valuable and sought-after oleochemicals include fatty alcohols (FAL), fatty acid methyl esters (FAME), fatty acid ethyl esters (FAEE), free fatty acids (FFA), fatty acid amides (FAA), glycerol (Fig. 4) etc.

These oleochemicals are widely used as surfactants in detergents, cosmetics, paints and pharmaceuticals, as well as a more

environmentally friendly alternative to fossil fuels [24-26].

No less interesting and in demand is the synthesis of polyols and hydroxyl-containing oligomers from fatty raw materials by etherification, esterification, amidation, ozonolysis, hydrogenation, hydroformylation, thiol-ene reaction (hydrothiolation), etc:

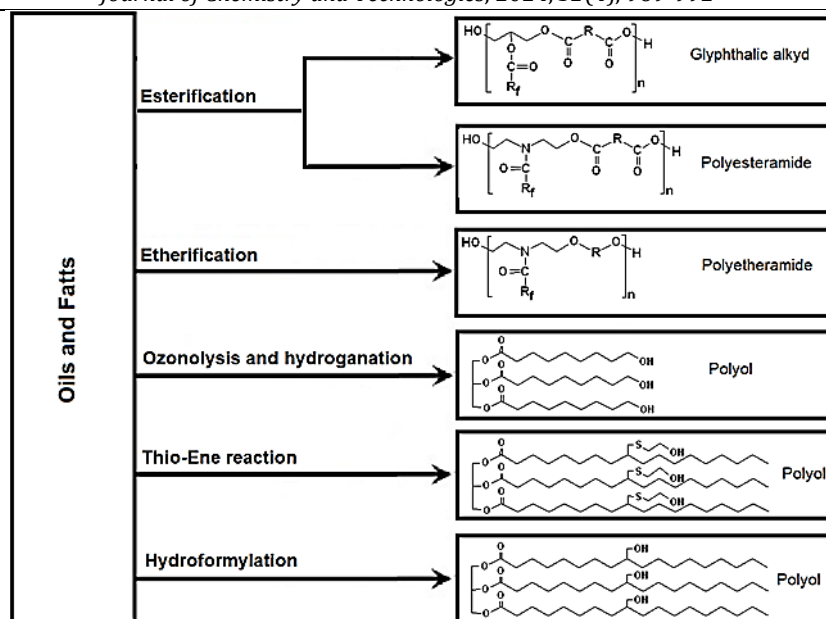

Fig. 5. Schematic representation of the preparation of different polyols from vegetable oils (were R_f – Fatty acid chains)

The polyols and hydroxyl-containing oligomers synthesized according to the Fig. 5 can be used for the synthesis of polyurethane binders and coatings with anticorrosive and antimicrobial properties.

At the same time, attention is drawn to the possibility of using oleochemicals in the synthesis of new polymers for highly demanding applications (for example, for components of electrochemical devices, etc), including in the biomedical field, to combat new threats such as COVID-19 [27].

In the following chapters we review promising in our opinion directions for synthesis of hydroxyl-containing monomers, useful for synthesis of polyesteramides, polyurethane amides, and metal-containing polymers based thereon.

Fatty acid amides synthesis technologies

In this review, we will focus on information about of the synthesis and study of hydroxyl-

containing polyols and amide derivatives of fatty acids (FAA) and polymers based thereon. Such researches is spurred on by the unique properties of biopolymers, as well as the variety of possible areas of their practical application.

Various amides are widely used in modern biologically active and pharmaceutical preparations. Reactions of their synthesis are not considered difficult and one of the most important reactions in organic chemistry [27].

Some FAA like N-arachidonylethanolamine (anandamide) and oleamide [28] also exhibit pronounced biological activity, and fatty acid monoethanolamides derived from andiroba oil [29; 30] have been demonstrated to have anticonvulsant properties. Given the high purity requirements for pharmaceutical ingredients, synthetic strategies chosen for FAA production often require use of oleyl or palmitoyl chloride [31].

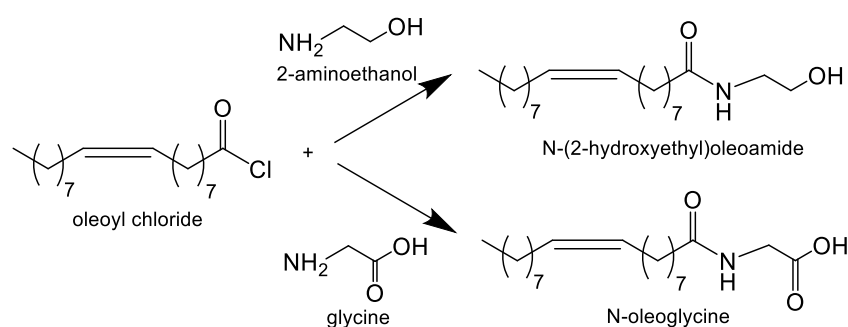

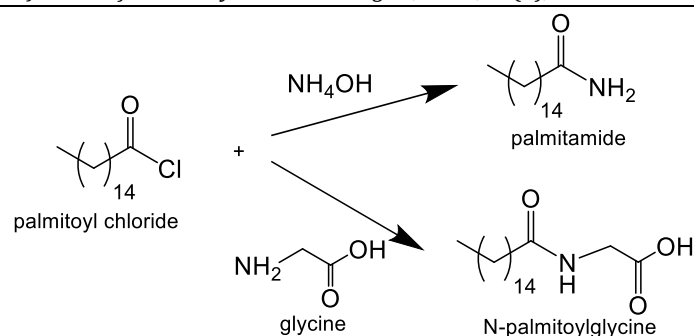

Fig. 6. The synthetic strategy for obtaining of the pharmaceutical fatty acid amides

Methods for producing FAA by reacting amino alcohols with higher fatty acids are also known. This scheme is used to obtain surfactants, corrosion inhibitors, antistatic agents for the textile industry and household chemicals, etc. [32], as shown below:

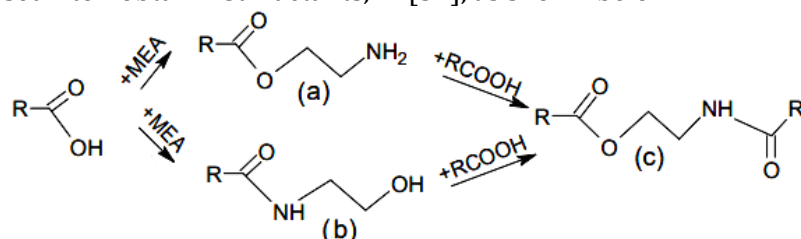

Fig. 7. Scheme of oleic acid ($R = C_{17}H_{33}$) and monoethanolamine (MEA) conversions: a - 2-aminoethyl (9Z)-octadec-9-enoate; b - (9Z)-N-(2-hydroxyethyl)octadec-9-enamide; c - 2-[(9Z)-octadec-9-enoylamino]ethyl (9Z)-octadec-9-enoate

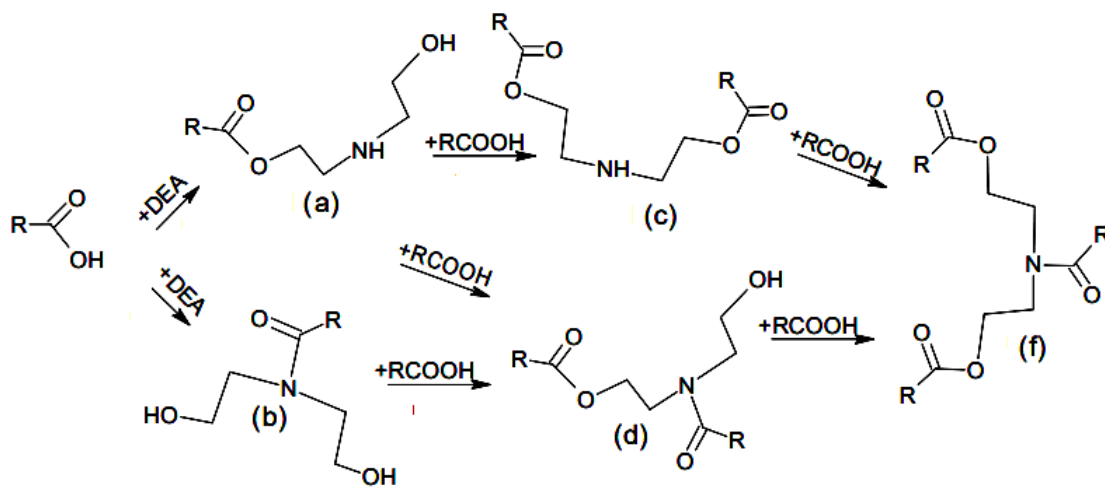

Fig. 8. Scheme of oleic acid ($R = C_{17}H_{33}$) and diethanolamine (DEA) conversions: a - 2-[(2-hydroxyethyl)amino]ethyl (9Z)-octadec-9-enoate; b - (9Z)-N,N-bis(2-hydroxyethyl)octadec-9-enamide; c - iminobis(ethane-2,1-diyl) (9Z,9'Z)bis-octadec-9-enoate; d - 2-[(2-hydroxyethyl)amino]ethyl (9Z)-octadec-9-enoate; e - 2-[(2-hydroxyethyl)imino]bis(ethane-2,1-diyl) (9Z,9'Z)bis-octadec-9-enoate; f - 2-[[[(9Z)-octadec-9-enoyloxy]methyl]imino]bis(ethane-2,1-diyl) (9Z,9'Z)bis-octadec-9-enoate

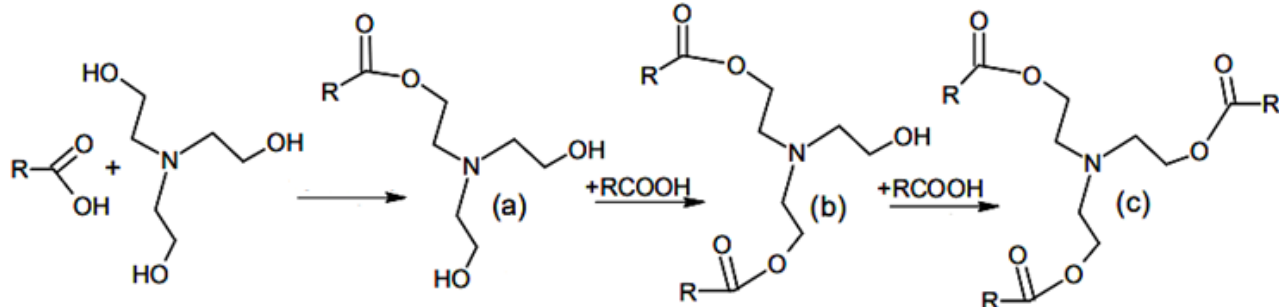

Fig. 9. Scheme of oleic acid ($R = C_{17}H_{33}$) and triethanolamine (TEA) conversions: a - 2-[bis(2-hydroxyethyl)amino]ethyl (9Z)-octadec-9-enoate; b - [(2-hydroxyethyl)imino]bis(ethane-2,1-diyl) (9Z,9'Z)bis-octadec-9-enoate; c - [[[(9Z)-octadec-9-enoyloxy]methyl]imino]bis(ethane-2,1-diyl) (9Z,9'Z)bis-octadec-9-enoate

Generally, such reactions are carried out at different temperatures using catalysts (for example, in the presence of sodium methoxide, orthophosphoric acid, complex platinum (II) compound of type $H_2[Pt(CN)_4] \cdot 3H_2O$, ion exchange resin of KU-2-8 type) or without them. Yield of product reaction is largely determined by the nature of the catalyst used. Authors of [32] studied patterns of interaction of oleic acid with a mixture of ethanolamines in the presence of the KU-2-8 cation exchange resin in the H-form at different ratios of reagents and amounts of catalyst. It has

been established that the preferentially N-acylation reaction of mono- and diethanolamine with oleic acid compared with the esterification reaction of hydroxyl groups of ethanolamines.

In the chemistry and technology of oleochemicals synthesis of fatty acid amides is also accomplished by a one-step aminolysis (amidation reaction) of vegetable and animal fats is widely used in the presence of both traditional catalysts and enzymatic biocatalysis [33], as shown below:

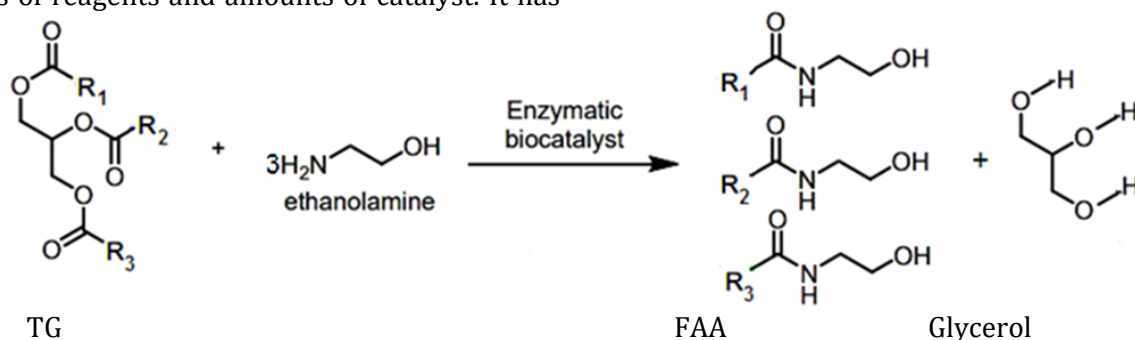

Fig. 10. Synthesis of fatty acid amides by the one-step triglyceride aminolysis from plant oil and ethanolamine. R_1 , R_2 , and R_3 are alkyl chains

Above reaction (Fig. 10) can be used to produce andiroba oil FAAs which can potentially be used in anticonvulsant medications.

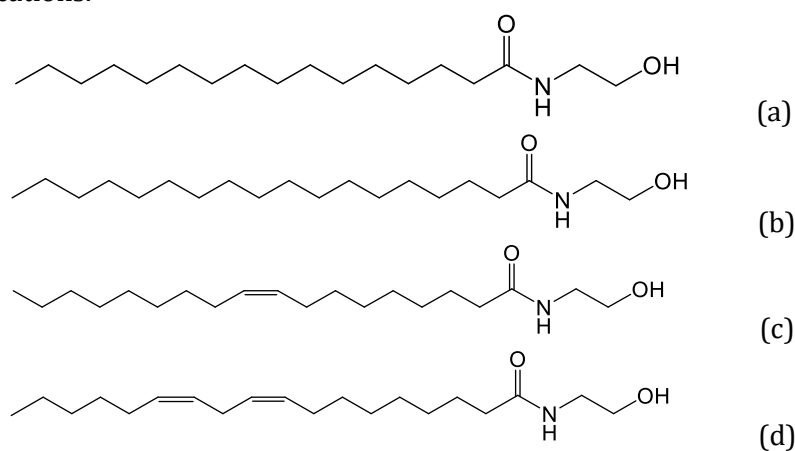

Fig. 11. Structure of andiroba oil-derived fatty acid amides (FAAs): a - palmitoylethanolamide, b - stearoylethanolamide, c - oleoylethanolamide, d - linoleoylethanolamide

According to [34], fatty acid amides can also be obtained in the absence of a catalyst, for example by reacting N-(2-hydroxyethyl)aminoethylamine with palm oil at a molar their ratio of 3:1 for 2 hours at a temperature of $140^\circ C$.

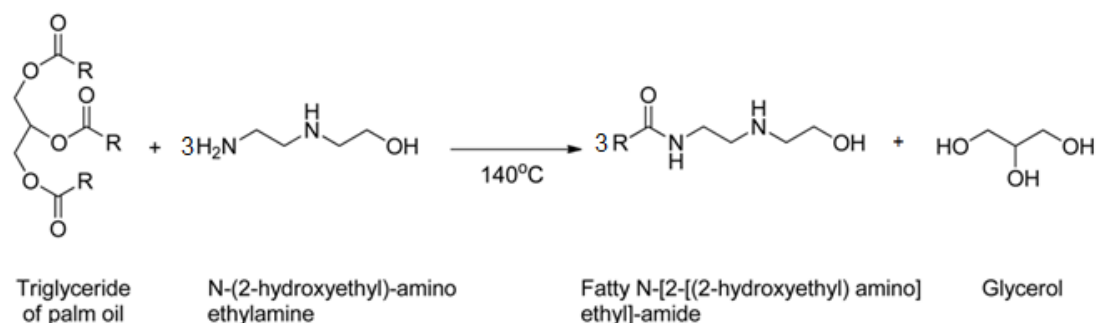

Fig. 12. Synthesis of fatty N-[2-(2-hydroxyethyl)aminoethyl]amide. R = alkyl chains of fatty acids of palm oil [34]

Palm oil fatty acid N-(2-hydroxyethyl)-aminoethylamides are excellent corrosion inhibitors with a protection efficiency of over 98 % [34]. They act as cathodic inhibitors, reducing the anodic dissolution of iron. The structural features allow the inhibitor to self-organize on the metal surface due to the formation of a dense hydrophobic film with the participation of FAA hydrocarbon chains. The results showed that the use of palm oil to produce "green" fatty acid amide inhibitors could lead to their widespread use in anti-corrosion materials. At the same time, the presence of only one potentially reactive hydroxyl group limits the possibility of their use as a monomer in the synthesis of polymer materials.

In [35] it's noted that compounds with amide bonds are of interest not only as corrosion inhibitors, but also as products with a wider range of applications: in agriculture, textiles, pharmaceuticals, polymers and cleaning industries, as well as in personal care products.

Existing acid amide synthesis methods are versatile, but are often considered "inelegant" due to serious concerns about waste generation and the high cost of target product synthesis and isolation. In this regard, the American Chemical Society Green Chemistry Institute (ACS GCI), which includes representatives from all major pharmaceutical companies in the world, voted in 2007 to develop new synthetic approaches for renewable raw materials-based amide production [28].

Our review focuses on advances in the synthesis of hydroxyl-containing amides of fatty acids of vegetable oils with functionality of 2 and

more, and also shows directions for the synthesis of promising esteramide-based polymers.

Industrial production of monomers, derived from hydroxyl-containing FAA – di-, tri- and polyols with hydroxyl functionality of 2 or more, from natural triglycerides (TG) is achieved in three ways:

- by reactions of TG with di- or triethanolamine;
- use of hydroxyl-containing triglycerides (for example, castor, ricin oils) in amidation reactions;
- modification of TGs in order to obtain their functionalized derivatives by epoxidation, hydroformylation, ozonolysis, thiol-ene reaction (as shown in Figure 5) followed by amidation.

A commercially available natural polyol is known – Ricinus communis oil (RC, castor oil), which contains about 90 % of ricinoleic acid residues (12-hydroxy-cis-9-octadecenoic acid, see Fig. 2c).

Castor (ricin) oil (RC) is classified as a non-drying oil, and its hydroxyl functionality is 2.7 [36]. Based on this, RC can be used as a polyol component in the synthesis of polyurethane materials (coatings, thermoplastic elastomers, rigid foams, elastic and semi-rigid foams, sealants and adhesives) without any additional chemical modification steps [37].

However, as polyols, RC have a number of disadvantages, which include not enough high functionality, as well as the presence of secondary hydroxyl groups in the oil structure, which are not highly reactive relative to isocyanates (See Table 1).

Table 1

Reactivities of different functional groups with $-N=C=O$ [38]

Functional group	Chemical Formula	Relative reaction rate	Resultant Linkage
Primary aliphatic amine	R-NH ₂	2500	Urea
Secondary aliphatic amine	(R) ₂ NH	500–1250	Urea
Primary hydroxyl	R-CH ₂ -OH	2.5	Urethane
Water	HOH	2.5	Urea
Carboxylic acid (non-dissociated)	R-COOH	1	Amide, (+CO ₂)
Secondary hydroxyl	(R) ₂ CH-OH	0.75	Urethane
Urea	R-NH-CO-NH-R	0.375	Biuret

But the most important disadvantage of using RC for the synthesis of polyurethanes (PU) is their limited functionality of the latter – only semi-flexible or semi-rigid materials can be obtained [36]. To obtain a new, more highly reactive

monomer for urethane formation reactions, it is recommended to obtain a triol [N,N-bis(2-hydroxyethyl)ricinoleamide, HERA], which contains in its structure two primary and one

secondary hydroxyl groups at the amide group, by amidation of RC.

RC amidation with diethanolamine is carried out without the use of highly volatile organic compounds (VOCs) in the presence of a catalyst –

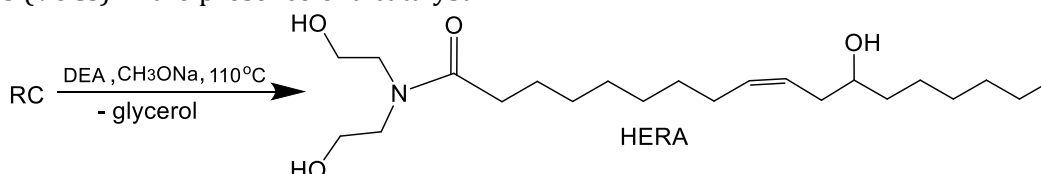

HERA is of interest for the synthesis of polyurethanes by an addition reaction between its –OH groups (of two primary and one secondary) and the –N=C=O group (for example, toluene-2,4-diisocyanate TDI). This reaction can be carried out using a minimal amount of solvent, which is a definite advantage. It is expected that in the structure of polyurethanes HERA will play the role of a soft segment with the presence of repeating amide bonds and will make it possible to obtain polymers with improved performance characteristics, notably the increased elasticity.

A similar approach was used in [39] for the synthesis of diethanolamide derivatives of cottonseed oil fatty acids (N,N-bis(2-hydroxyethyl) cottonseed oil fatty amide, CFA) and FAA-based binder for use in coatings. The CFA synthesis was carried out in a glass reactor equipped with a stirrer. Into reactor calculated amounts of diethanolamine (0.32 mol) and

sodium methoxide and at a temperature of 110°C. The amidation reaction proceeds via a base-catalyzed bimolecular nucleophilic acyl substitution (S_N2) reaction mechanism.

sodium methoxide (0.007 mol) were loaded, resulting mixture was heated to 80 °C for 15 minutes with constant stirring. Then 0.1 mol of cottonseed oil was added dropwise to the reaction mixture over 60 minutes with constant stirring with a gradual increase in temperature to 120 °C. Reaction was carried out for 3 hours at 120 °C.

The disadvantages of such a one-step synthesis include the release of glycerol into the reaction mixture and the corresponding problems in purifying the target product. In this regard, a two-step scheme is more promising for the synthesis of fatty acid amides. In this case, at the first stage, the synthesis of methyl (FAME) or ethyl (FAEE) esters of fatty acids. At this stage the released glycerol is quite easily removed from the reaction zone by decanting. At the second stage, synthesis of diethanolamide derivatives of the fatty acids from the corresponding esters is carried out under conditions shown in Figure 13.

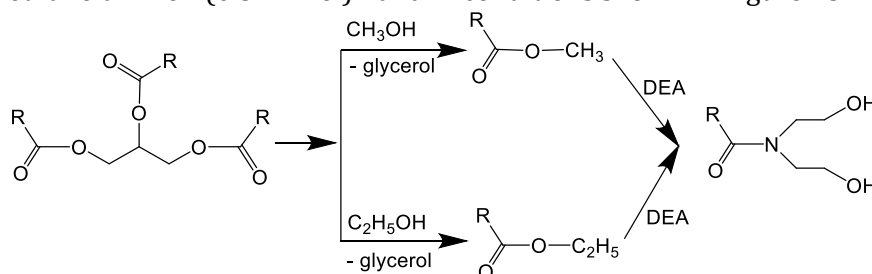

Fig. 13. Two-step synthesis of fatty acid diethanolamides

The fatty acid esters obtained according to the scheme above are of interest as raw materials for the production of diols, polyols and hydroxyl-containing FAA, as well as monomers for the synthesis of polyesteramides and polyurethanes based thereon.

Aliphatic diols, polyester polyol derivatives of fatty acid amides based on plant oils

It is known that presence of polyesters in coatings provide them excellent oxidative stability. At the same time, the presence of an ester bond in such materials (coatings) reduces their resistance to water, especially in the presence of acids and bases. The main task for researchers is to find the optimal structure of polyester polyols

that provide an improved balance of hydrolytic and oxidative stability while maintaining flexibility and chemical resistance of polymer materials.

At the same time, polyester diols and polyols synthesized from plant oils are promising candidates for creating environmentally friendly (green) coating formulations with low volatile organic compounds (VOCs) emissions that have excellent physical and mechanical characteristics, sufficiently high elasticity and hydrolytic stability [40].

The main problems with the widespread introduction plant oil-based diols and polyether polyols in coatings industry have been and still are their high cost and low reactivity (due to the

presence of secondary hydroxyl groups (R_2)CH-OH).

The disadvantages of existing methods for their synthesis include poor control and reproducibility of the processes, as well as low color values of the synthesized polyols, especially when insufficiently purified (unrefined) plant oils are used for the synthesis [41; 42].

In our opinion, an attractive strategy for the synthesis of polyols with good reactivity (due to the formation of primary hydroxyl groups $R-CH_2-OH$ in the structure of fatty acid residues) and

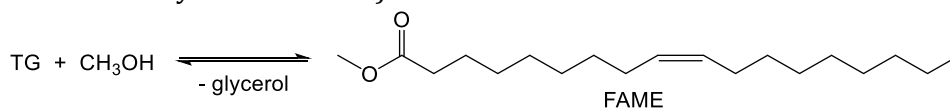

Step 2: Hydroformylation process

In the second step, olefinic groups of the isolated FAME are controllably converted to aldehyde groups through a catalyzed hydroformylation reaction involving carbon

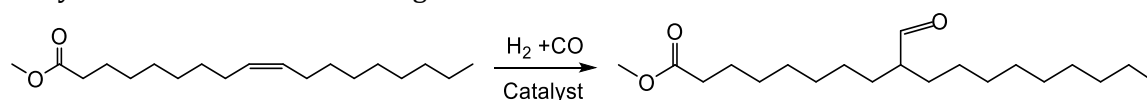

Step 3: Hydrogenation process

In the third step, primary aldehydes are hydrogenated to primary hydroxyl groups, and the unreacted double bonds are saturated. This step results in the formation of a monomer that can be reacted with diols to synthesize higher molecular weight polyether polyols.

Considering that FAMEs are a mixture of fatty acid esters, which may contain FAMEs with a

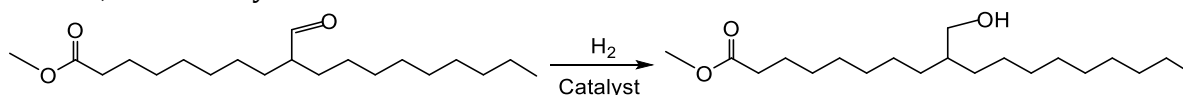

Step 4: Transesterification process

In the fourth step, the resulting monomer is transesterified with a suitable glycol. In this process, the molecular weight of the polyol increases due to the condensation of the monomer with the diol (polyol).

As it can be seen from the diagram below, the monomer synthesized at the previous stage can be

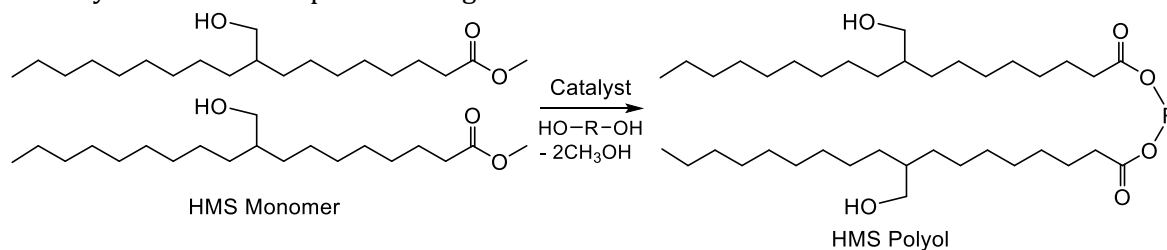

As can be seen from Figure 14, synthesized products are a mixture of polyols with different functionality, with a predominant functionality of 2. The percentage of polyester polyols with

controlled functionality, had been proposed by the authors of [40]. This unique process for the synthesis of polyols with primary hydroxyl groups and no unsaturated groups is based on the four reactions shown below.

Step 1: Methanolysis

In the first step, a natural triglyceride (soybean or sunflower oil) containing unsaturated fatty acid residues (for example, of oleic acid) is transesterified with methanol to produce FAMES and glycerol.

monoxide and hydrogen. Resulting aldehyde functionality can be controlled by the depth of the reaction, as well as of the double bonds number in the starting FAME.

higher degree of unsaturation (due to the presence of primarily linoleic and linolenic acid residues), it is recommended to use oleic varieties of plant oils for synthesis in order to avoid obtaining monomers with several hydroxyl groups. It is important to take this point into account when optimizing synthesized polyol-based polymer compositions.

used in reactions with diols of various structures and molecular weights, based on the needs for obtaining a polyether polyol with the required molecular weight and average functionality, as well as to ensure compatibility of compatibility with other components during further processing as part of polymer compositions.

hydroxyl functionality of 2 depends on history of FAMES purification (HMS is purified (concentrated) methylhydroxy methylstearate) obtained in steps 1-3 as well as on the nature of

plant oil (sunflower or soybean) used for synthesis.

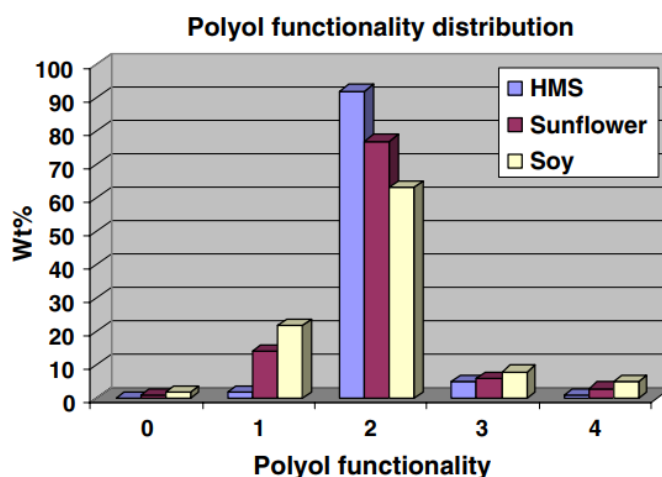

Fig. 14. Seed of oil polyol functionality distribution [40]

Polyols of this type are colorless liquids with low viscosity at room temperature, which is an undoubted advantage. Most importantly, they can be used to produce environmentally friendly (“green”) coating formulations with low VOC emissions and excellent hydrolytic stability, with an optimal combination of strength and elasticity.

However, it should be taken into account that the presence of a fraction of polyols with a functionality of less than two will reduce the exploitation properties of coatings. At the same time, the use of a fraction of polyols with a functionality higher than two in the synthesis of polyurethanes can lead to the production of prepolymers with higher viscosity values than desired.

Authors of [40] also note the importance of assessing the solubility parameters of polyols based on plant fats, since they are often used in combination with other resins in coating compositions. This parameter describes a thermodynamic property useful in determining the miscibility of two substances.

Solubility parameters for vegetable fat-based polyols can be calculated using the method developed by Hoy and the formulas given below:

$$\delta_T = \left(\sum FT + 135.1 \right) / V_M \quad [43],$$

where ΣFT – the sum of all the group molar cohesion constants (FT);

V_M – molar volume (molecular weight divided by density).

$$\delta_T = \left(\delta_{H-Bonding}^2 + \delta_{Polar}^2 + \delta_{Nonpolar}^2 \right)^{1/2} \quad [44; 45],$$

where $\delta_{H-Bonding}$ – hydrogen bond solubility parameter;

δ_{Polar} – polar solubility parameter;

$\delta_{Nonpolar}$ – nonpolar solubility parameter.

Calculated solubility parameters of various polyols based on various vegetable oils and synthesized acrylic polyols are provided in Table 2.

Table 2

Solubility parameters (cal/cc) ^{1/2} of seed oil polyols			
Solubility parameters	HMS polyol	Sunflower polyol	Soy polyol
δ_{Total}	8.88	8.88	8.87
$\delta_{H-Bonding}$	2.74	2.67	2.54
δ_{Polar}	3.29	3.26	3.20
$\delta_{Nonpolar}$	7.78	7.79	7.81

The general solubility parameter of plant oil-based polyols is quite low (about 8.9), which confirms their hydrocarbon nature and also allows them to be used in conjunction with non-polar acrylic polyols. This fact must be taken into account when creating acrylic polyols-based compositions.

A useful technological property of the synthesized polyols is that at room temperature they are low viscosity liquids unlike traditional polyether polyols, which at the same conditions are solids or high viscosity liquids. This property is very useful to take into account when developing the compositions of highly filled coatings and adhesives.

Another advantage of oleochemical polyols is their ability to significantly reduce the viscosity of acrylic polyols, for example, those synthesized from a mixture of monomers 2-Hydroxyethyl methacrylate:2-ethylhexyl methacrylate:Isodecyl methacrylate:t-Butyl methacrylate taken at mass ratio of 25 : 12 : 28 : 35 wt%.

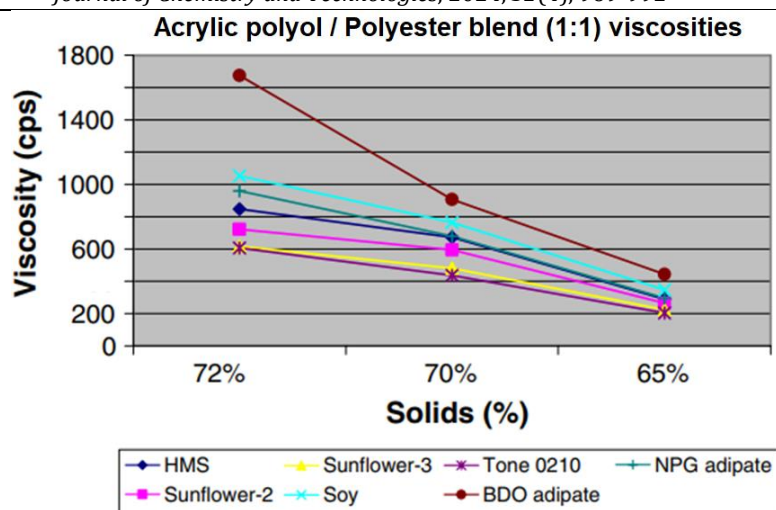

Fig. 15. Comparative decrease in viscosity of acrylic polyol in presene of biopolyols and synthetic polyols: (1,4-butanediol)adipate (BDO), (neopentyl glycol) adipate (NPG), low molecular weight polycaprolactone polyol (TONE® 0210) [40]

At the same time, biopolyols are characterized by a fairly low glass transition temperature T_g ($-60\text{ }^\circ\text{C}$), which allows them to be used in combination with polyols with a higher T_g . Using such mixtures, it is possible to obtain chemically resistant coatings with high elasticity and resistance to impact loads, while maintaining good hardness and adhesion to the protected surface.

As shown above, technology of TG-based of polyols synthesis happens without deep chemical transformations.

Using fairly simple chemical reactions, it is possible to obtain from TG valuable monomeric and oligomeric intermediates for the synthesis of poly(urethanamides), poly(esteramide), and poly(etheramide), promising film-forming agents for paints and varnishes, as well as additives and modifiers for large-scale polymer materials. At the same time, there is an opinion that it is necessary to expand the raw material base of plant oils, to look for an alternative to hemp, linseed and soybean oils, which are widely used in the coatings industry and are quite expensive.

In [46], it is proposed to use *Balanites roxburghii* oil (BRO) for synthesis of oleochemicals. The BRO is obtained from an acorn-shaped product growing on thorny bushes or trees common in the arid regions of India, Africa, Syria and Arabia. BRO has fatty acid composition of: Palmitic acid (16 : 0) 17 %, Palmitoleic acid (16 : 1) 4.3 %, Stearic acid (18 : 0) 7.8 %, Oleic acid (18 : 1) 32.4 %, Linoleic acid (18 : 2) 31.3 %, and Linolenic acid (18 : 3) 7.2 %. To obtain polyols, BRO oil was chemically modified in several stages.

At the first stage, oil was subjected to epoxidation with the traditional use of glacial acetic acid, H_2SO_4 and hydrogen peroxide with the target epoxidized product (EBRO) yield of 74.32 %.

At the second stage, the so-called polyhydroxyl oil (PBRO) was obtained by reacting EBRO with an aqueous solution of H_2SO_4 at $65\text{ }^\circ\text{C}$ according to the method described in [47].

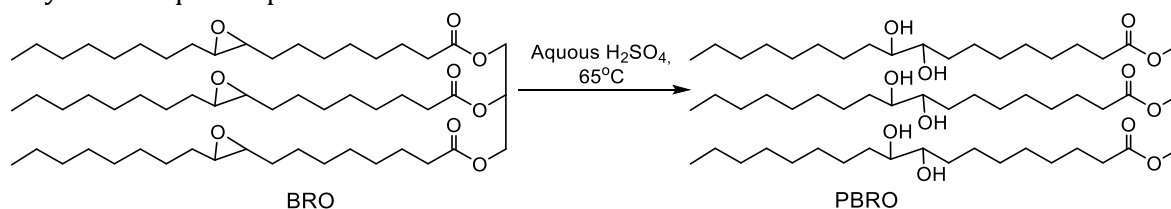

Fig. 16. Synthesis of PBRO

The final, third stage was the synthesis of the polyhydroxyl fatty acid amides (FAP) which were obtained by mixing 0.35 mol of diethanolamine

and 0.007 mol of sodium methoxide, heating the resulting mixture to $110\text{ }^\circ\text{C}$, after which PBRO (0.1 mol) was added dropwise for 60 minutes.

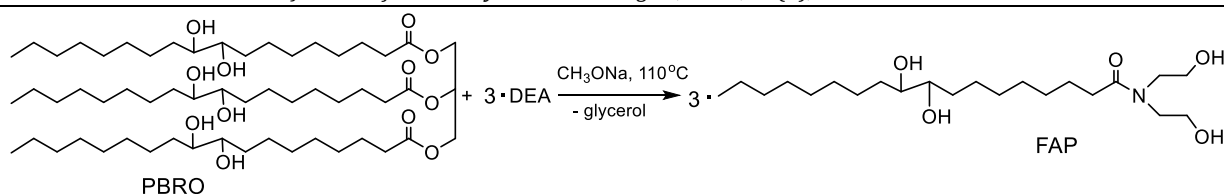

Fig. 17. Synthesis of FAP

At the end of the reaction, product was dissolved in diethyl ether, washed with 15 % NaCl solution and dried over anhydrous sodium sulfate. The ether layer was filtered and evaporated in a vacuum evaporator to obtain FAP.

Theoretically, FAP can be used for the synthesis of polyurethane and polyesteramide polymer materials.

Synthesis and properties of polyurethanamides, polyesteramides and metal-containing derivatives based thereon

Monomers (diols and polyols, fatty acid amides polyol derivatives) synthesized from plant fats (drying, non-drying and semi-drying oils) have attracted attention from a scientific and industrial point of view due to the presence of reactive functional groups in them – hydroxyl and carboxyl groups and unsaturated bonds.

They are not only suitable as starting materials for the synthesis of polymers such as polyesteramides (PEsA), polyetheramides (PEA) and poly(urethanamides) (PUA), but also can be used as cross-linking agents, polymer chain extenders and as reactive diluents [48–51].

In the technical literature there are a large number of publications devoted to the synthesis of the aforementioned polymers; we will give only individual, classic, in our opinion, examples that reflect the basic principles of the synthesis processes and the main properties of the synthesized eco-friendly polymers.

Synthesis of polyurethanamides (PUA)

The PUA synthesis is based on the reaction of hydroxyl-containing compounds with aliphatic and aromatic isocyanates. Optimization of the PUA properties is carried out by choosing the structure and functionality of the hydroxyl-containing and/or polyisocyanate component, as well as searching for the optimal ratio of reacting NCO/OH groups.

The synthesis, structure and properties of promising, in our opinion, diols and polyols based on fatty plant raw materials (oleochemicals) were reviewed by us in the previous sections 1 and 2. Aliphatic and aromatic isocyanates, widely used for the synthesis of polyurethanes, including polyurethanamides, are listed in table 3.

Table 3

Structural formulas of monomers for the synthesis of promising polyurethanes and polyurethanamides		
Structural formula	Name	Functionality
Diols, polyols		
	Esterdiols, containing two highly reactive primary hydroxyl groups [40]	<2
	Ricinus oil with theoretically three secondary hydroxyl groups [36]	~2,7
	Diols, aliphatic fatty acid diethanolamide derivatives with two primary hydroxyl groups [39]	2
	Triols, N, N-bis (2-hydroxyethyl)-ricinoleamide, castor oil derivatives (HERA) with two primary and one secondary hydroxyl groups [36]	> 2
	Fatty amide polyol (FAP) made from <i>Balanites roxburgii</i> oil with two primary and two secondary hydroxyl groups [47]	> 3

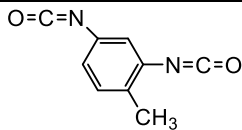
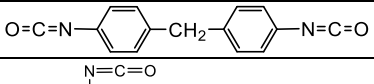
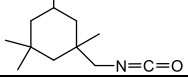
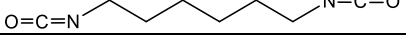
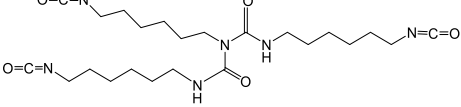
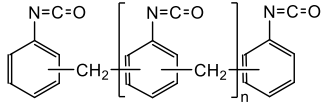
Isocyanates [48]		
	toluene-2,4-diisocyanate (TDI)	2
	Methylene diphenyl diisocyanate (MDI)	2
	Isophorone diisocyanate (IPDI)	2
	1,6-hexamethylene diisocyanate (HDI)	2
	Biuret of diisocyanate hexamethylene	2
	Polymethylenediphenyldiisocyanate (PMDI)	n

Generally, in polyurethane chemistry optimal molar ratio $[-N=C=O]/[OH]$ should be 1,0-1,1, at which maximum molecular weight of the polymer is achieved (see Figure 18):

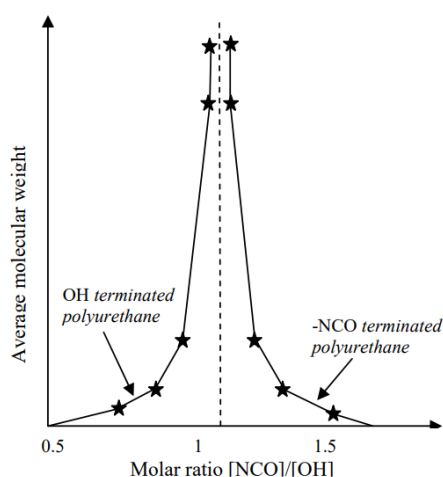

Fig. 18. Effect of molar ratio $[NCO]/[OH]$ on the average molecular weight of polyurethane [48]

Below are several strategies for the synthesis of polyurethanamides from plant-derived monomers. One should take into account the heterogeneity of the structure and composition of oleochemicals, due to the variability of the plant TG fatty acid composition and corresponding variability of monomer composition. Thus, for the triol *N,N*-bis(2-hydroxyethyl)ricinoleamide (HERA), the actual hydroxyl functionality is 2.7. In this regard, the optimal molar ratio of $[-N=C=O]/[OH]$ groups should be determined experimentally, as was done in [36].

For example, the interaction of HERA with toluene-2,4-diisocyanate (TDI) is carried out in the presence of the minimum possible number of organic solvent (see Fig. 19, Table 4):

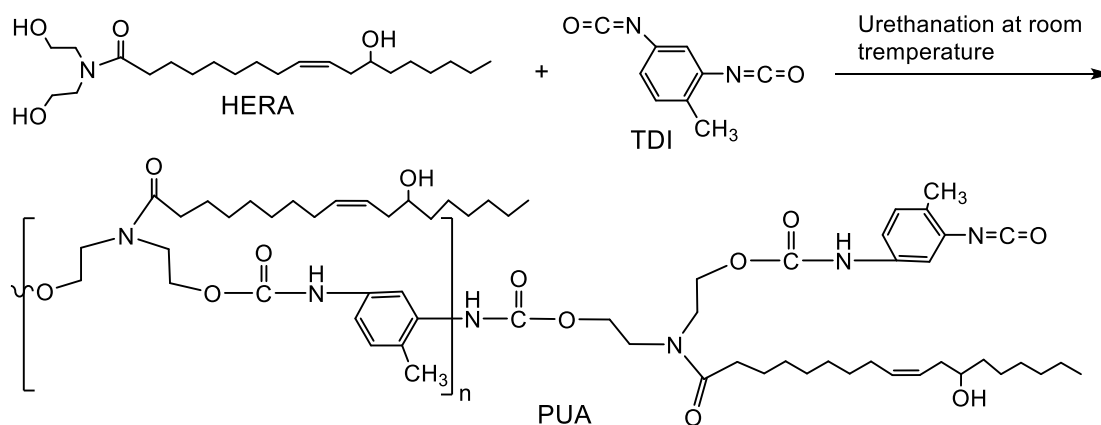

Fig. 19. Polyurethaneamide synthesis

Chemical composition for the synthesis of PUA			
Composition	HERA (mole)	TDI (mole)	[NCO]/[OH] ratio
PUA-0.8	1.0	0.8	1.6/3
PUA-1.0	1.0	1.0	2.0/3
PUA-1.2	1.0	1.2	2.4/3

In this case, PUA-1 turned out to be the optimal composition. When using HERA for the synthesis of polyurethanes, the $[-N=C=O]/[OH]$ molar ratio can be below 1, depending on the end use of the resulting PUA.

PUA synthesized according to the Figure 19 is completely soluble (100%) in ethyl methyl ketone (EMK), chloroform, carbon tetrachloride, DMF (dimethylformamide), DMSO (dimethyl sulfoxide), THF (tetrahydrofuran) and diethyl ether, while exhibiting 20 % solubility in methanol, ethanol and being insoluble in water.

The high solubility of these resins in polar and non-polar solvents is due to the presence of long hydrocarbon chains of fatty acids and polar groups of the resin.

Synthesis of polyesteramides (PEsA)

Oleochemical-based PEsA is a special class of polymers that combines the properties of both polyesters and polyamides.

They exhibit promising mechanical properties and chemical resistance along with excellent

thermal stability; some of them are used to produce effective antimicrobial and biologically safe anti-corrosion coatings. Generally, PEsA are medium- and high-viscosity products. On their basis it is possible to obtain binders and film formers that do not contain solvent at all or contain it in minimal amounts. The presence of ester $-C(O)-O-R$ and amide $-NH-C(O)-R$ functional groups in the main chain of PEsA determines their fairly high thermal stability, increased water and chemical resistance, coatings based on them are characterized by higher hardness in comparison with traditional alkyds [52]. At the same time, a special technological challenge is the need to develop cold-curing PEsA compositions [53].

Thus, *N,N*-bis(2-hydroxyethyl)amides of cottonseed oil fatty acids (CFA) are of interest as a monomer for the synthesis of polyesteramides according to the scheme below:

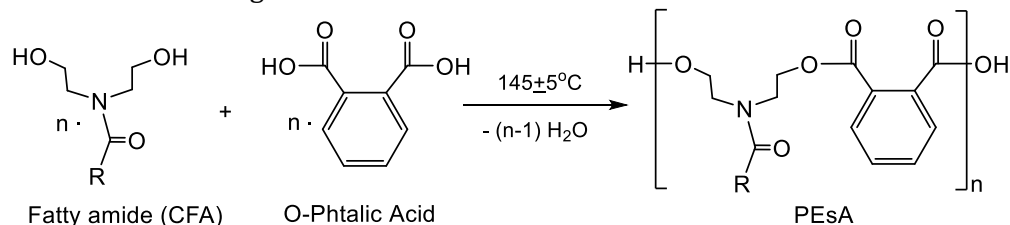

Fig. 20. Synthesis of oil polyesteramide (PEsA)

To synthesize PEsA, an equimolar amount of cottonseed oil fatty amides (CFA) (0.54 mol) and phthalic acid (0.54 mol) was dissolved in xylene (50 ml), the reaction mixture was heated at $145 \pm 5^\circ\text{C}$ with continuous stirring under inert atmosphere. The progress of the reaction is traditionally monitored by analyzing the acid number at regular intervals and by monitoring the amount of water collected in the Dean Stark trap. Polyesteramide in purified form was obtained after removing excess xylene using a vacuum rotary evaporator.

To improve the physical, mechanical and anti-corrosion characteristics of coatings, it is recommended to further modify polyesteramides using hydroxides (for example, aluminum hydroxide Al(OH)_3) and various metal acetates (Mn(II) , Co(II) and Cu(II) [54] Zn(II) [57], Cd(II) [55, 56] and more), vinyl monomers and peroxide

type initiators [57], boric acid, aliphatic or aromatic isocyanates, polyisocyanates [58], etc.

The prospect of developing synthesis methods of organic-inorganic polymers (metalloids) has always attracted the interest of researchers. The properties of a sufficiently large number of petrochemicals-based polymers of this class have already been studied. Semi-inorganic petrochemicals-based polymers containing B-O, B-S, B-N, and B-P bonds are also known. They exhibit increased thermal stability, unique electrical, antibacterial and antifungal properties [59]. It is expected that similar polymer systems based on vegetable seed oils (VSOs) derived products will be even more promising due to the inherently high flexibility of biobased polymers, their excellent physical and chemical properties, namely improved hydrolytic and thermal stability

associated with the hydrophobic nature of the constituent triglycerides.

Interest to metal containing polymers is gained significance from the scientific and industrial viewpoints due to their unusual properties and versatile practical applications. Thermal stability, electrical conductivity, high toughness, flame retardancy, catalytic and biocidal activities, gloss, protective efficiency, reduction in curing temperature as well as the functional properties of many polymers can be drastically altered by the incorporation of metals to polymer structure.

Below we will give examples of the synthetic approaches to creating metal-containing biopolymers. It should be noted that traditional synthetic methods used to produce plant-oil based polymers (film-formers) have a number of disadvantages, among which is need for use of volatile organic solvents and multi-staged nature of the processes.

In [60] authors describe the solvent-free synthesis of Cd-, Zn-containing polyurethanamides [Cd-PEsA, Zn-PEsA] according to the scheme below:

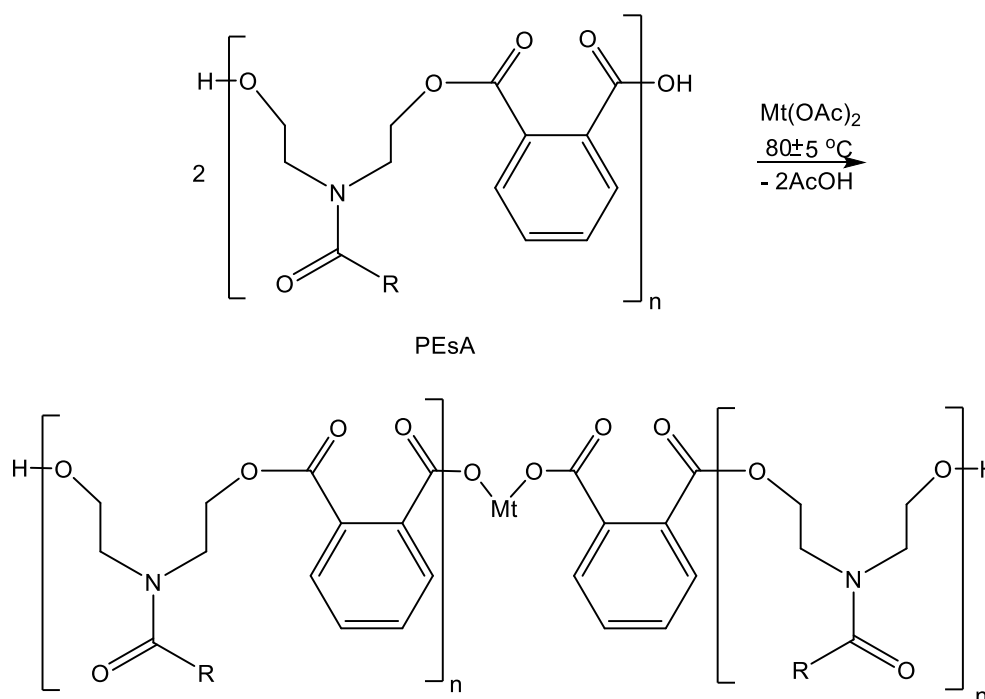

Fig. 21. Synthesis of metal-containing polyesteramide (Mt-PEsA)

The synthesis of Cd-, Zn-containing polyurethanamides was carried out in situ by a direct condensation reaction of linseed oil N,N-bis(2-hydroxyethyl)amide (0.2 mol), phthalic anhydride (0.2 mol) and divalent zinc acetate/cadmium acetate (0.0175 – Zn(Cd)-PEsA-1, 0.025 – Zn(Cd)-PEsA-2, 0.0325 – Zn(Cd)-PEsA-3, 0.04 – Zn(Cd)-PEsA-4 and 0.0475 – Zn (Cd)-PEsA-5, mol) without using any solvent at low temperature ($80 \pm 5^\circ\text{C}$). During the synthesis, a noticeable increase in product viscosity was observed in a short time with the addition of 0.755 wt.% cadmium/zinc acetate, after which the resin turned into a gel. In this regard, to obtain film-forming agents with good technological properties – ability to be evenly distributed over the protected surface, the authors recommend introducing no more than 0.755 % acetate of the corresponding metal.

The maximum temperature of use for the best sample of synthesized polymers is $320\text{--}330^\circ\text{C}$; samples Zn-PEsA-4 and Cd-PEsA-3 exhibit the highest antibacterial activity against *Escherichia coli* (*E. coli*) and *Staphylococcus aureus* (*S. aures*). Table 5 shows data on the performance and anti-corrosion properties of metal-containing PEsA.

Thus, it was found that the introduction of divalent metal cadmium and zinc into the structure of polyesteramides improves their mechanical and chemical/anti-corrosion properties in comparison with non-metal-containing polyesteramides.

It was later established [54] that when using a similar procedure with Mn(II), Co(II) and Cu(II) acetates and PEsA, a metal acetate reacts with PEsA in situ without the presence of any organic agent through direct polycondensation (as in Fig. 21).

Physical-mechanical and anti-corrosion (chemical) properties of PEsA and its metal-containing Zn-PEsA and Cd-PEsA derivatives

Resin code	Baking		Scratch Hardness (kg)	Corrosion resistance				
	T, °C	Time (min)		H ₂ O (10 days)	NaOH (5%, 2 h)	HCl (5%, 10 days)	NaCl (3.5%, 10 days)	Xylene (10 days)
PEsA	220	10	2,0	E	a*	c	d	d
Zn-PEsA-1	180	20	2.5	E	a	e	c	e
Zn-PEsA-2	170		2.7	E	a	e	e	e
Zn-PEsA-4	160		3.2	E	a	e	e	e
Zn-PEsA-5	160		2.6	C	a	f	c	c
Cd-PEsA-1	170		2.8	F	a	f	e	e
Cd-PEsA-2	160		3.0	F	a	f	e	e
Cd-PEsA-3	150		3.5	E	a	e	e	e
Cd-PEsA-4	150		3.0	C	a	f	c	e

Note: a) film completely removed from surface, b) film cracked and partially removed, c) slight loss of gloss, d) loss of gloss, e) unchanged and f) film slightly swollen. *The film is completely removed after 1 hour.

With an increase in the metal content in Mn(II)-PEsA/Co(II)-PEsA/Cu(II)-PEsA samples, the total synthesis time decreases due to the catalytic effect of the metal itself. It has been observed that the synthesis of Co(II)-PEsA and Cu(II)-PEsA occurs in a shorter time frame compared to other systems. This is due to the higher reactivity of Co(II) and Cu(II) than Mn(II) due to the difference in their electronic configuration. Co(II) and Cu(II) have partially filled d-orbitals (d7 and d9), which give them higher reactivity compared to Mn(II), which has half-filled (d5) d-orbitals, which is provide of the higher stability and lower reactivity.

Mn(II)-PEsA/Co(II)-PEsA/Cu(II)-PEsA also showed excellent antibacterial properties against *S. aureus* and *E. coli*. The observed diversity of properties suggests that Mn(II)-PEsA can be used as an environmentally friendly protective "green" material, thermally stable up to 320–330 °C.

In [61] authors report the synthesis and antimicrobial activity of cadmium-containing biopolymers based on the condensation products of *N,N'*-bis-2-hydroxyethyl amides of castor/soybean oil fatty acids and sebacic acid. In this case, the PEsA and cadmium hydroxide Cd(OH)₂ were used for synthesis.

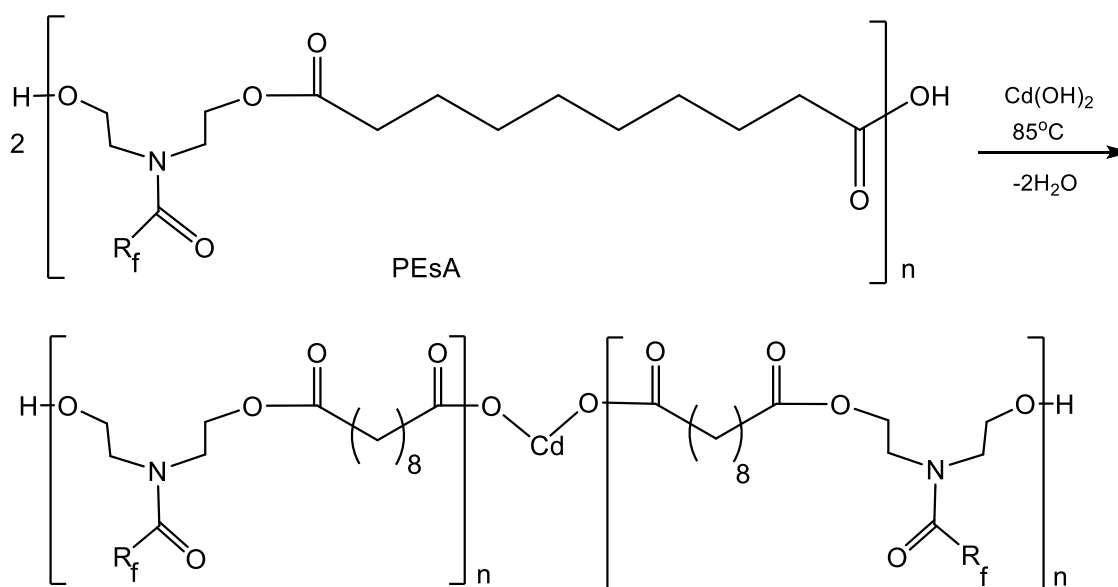

Fig. 22. Synthesis of cadmium-containing polyesteramide (Cd-PEsA) based on the condensation products of *N,N'*-bis-2-hydroxyethyl amides of castor/soybean oil and sebacic acid

It was found that both Cd-PEsA polymers (based on castor and soybean oil derivatives) are insoluble in water due to the hydrophobic nature of triglycerides. At the same time, they are completely soluble in CHCl_3 , benzene, CH_2Cl_2 ,

toluene, DMSO, DMF and THF. This indicates the absence of cross-links as a result of the inclusion of cadmium in the polymer chain. After isolation and purification, the Cd-PEsA precipitate was washed with water, and the filtrate was

qualitatively tested for the presence of cadmium ions, which was found to be negative. Preliminary testing of the biological activity of Cd-PEsA polymers has shown that they are much effective against fungi than against bacteria. These polymers have the potential to be used as antimicrobial agents and for treating superficial fungal infections. The authors noted the

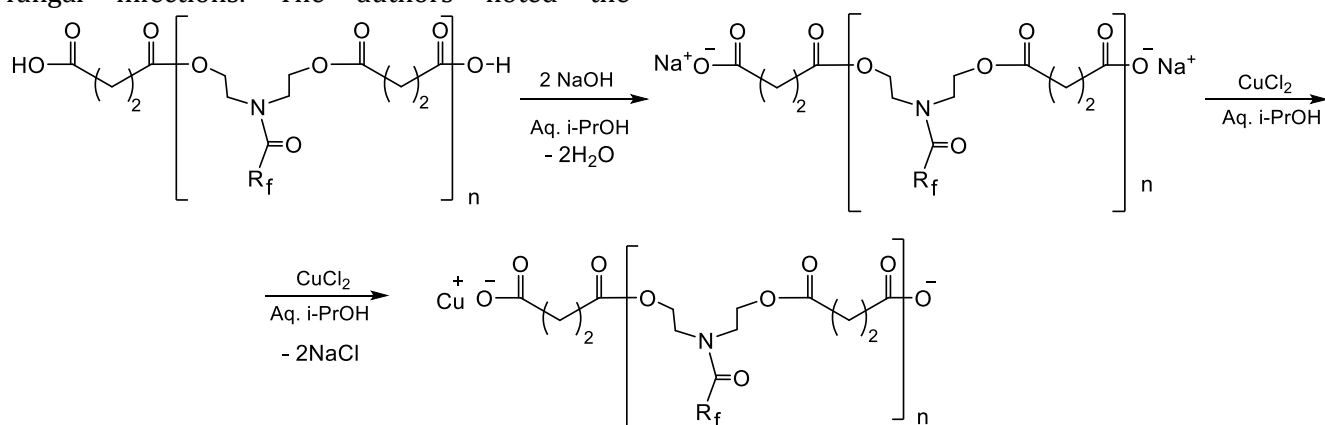

Fig. 23. Synthesis of copper-containing polyesteramide (Cu-PEsA) based on the condensation products of *N,N'*-bis-2-hydroxyethyl amides of the linseed oil fatty acids and succinic acid [62]

The synthesized Cu-PEsA contains an amide group with a long unsaturated alkyl side chain and is soluble in common organic solvents. To obtain anti-fouling coatings, due to insufficiently high strength properties, it is recommended to modify Cu-PEsA with chlorinated rubber resin CR 20. When immersed in sea water, controlled leaching of copper is observed (Fig. 24), as well as a self-polishing effect of the coating.

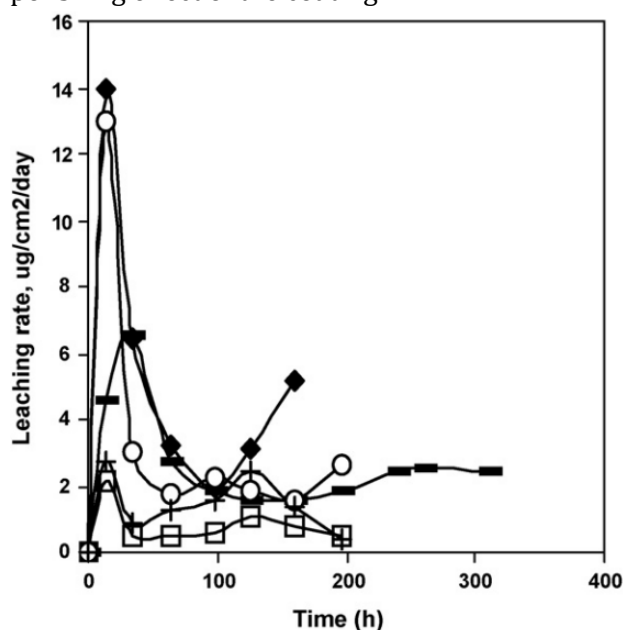

Fig. 24. Sea water leaching of copper from Cu-PEsA/CR 20 film: Cu-PEsA/CR 20 (100/0, w/w) (◆); Cu-PEsA/CR 20 (70/30, w/w) (■); Cu-PEsA/CR 20 (50/50, w/w) (○); Cu-PEsA/CR 20 (30/70, w/w) (+); Cu-PEsA/CR 20 (20/80, w/w) (□) [62].

possibility of commercial application of Cd-PEsA as an anti-corrosion and anti-bacterial coating material.

The work [62] describes an attempt to synthesize an organocopper polymer based on PEsA, the synthesis strategy of which is given below:

It was found that the steady-state leaching rate is in the range of 1–3 $\mu\text{g}/\text{cm}^2/\text{day}$. Further research is underway to increase the leaching rate to achieve a reasonable antifouling performance. Maximum copper content in the polymer composition should reach about 4 wt.%.

It should be noted that the type of Cu-PEsA structure can be changed by changing the length of the alkyl chain of the acidic component, the nature of the fatty acid residue R_f , as well as the degree of its unsaturation, etc. As the authors note, the rate of copper leaching from Cu-PEsA can be optimized by selecting of precursors for PEsA synthesis as well as selecting the suitable co-binder agent (modifying additive).

Modern technologies require the development of environmentally friendly polymer materials with desired mechanical properties. Today, synthesis using microwave radiation is considered as one of the directions for obtaining of new polymer materials. The use of microwaves makes it possible to reduce reaction time, obtain the target product with high yield, at minimum environmental impact that comply with green chemistry protocols.

Generally, traditional reaction methods for producing polyurethanamide and its metalation are multi-stage and usually take 8–12 hours for the complete formation of a metal-containing polymer.

Alam M. et al. [63] proposed to carry out the synthesis using microwaves, which makes it

possible to reduce the reaction time to 4–6 min. In this case, an increased yield of the target product is observed due to the minimization of side reactions, which usually occur in localized hot spots in the reaction volume when using traditional heating methods.

So, it was synthesized metal-containing polyurethaneamide (Mt-PUA) using microwave heating by metalation of diethanolamide castor oil with followed by urethanation, the synthesis scheme of which is shown in Fig. 25.

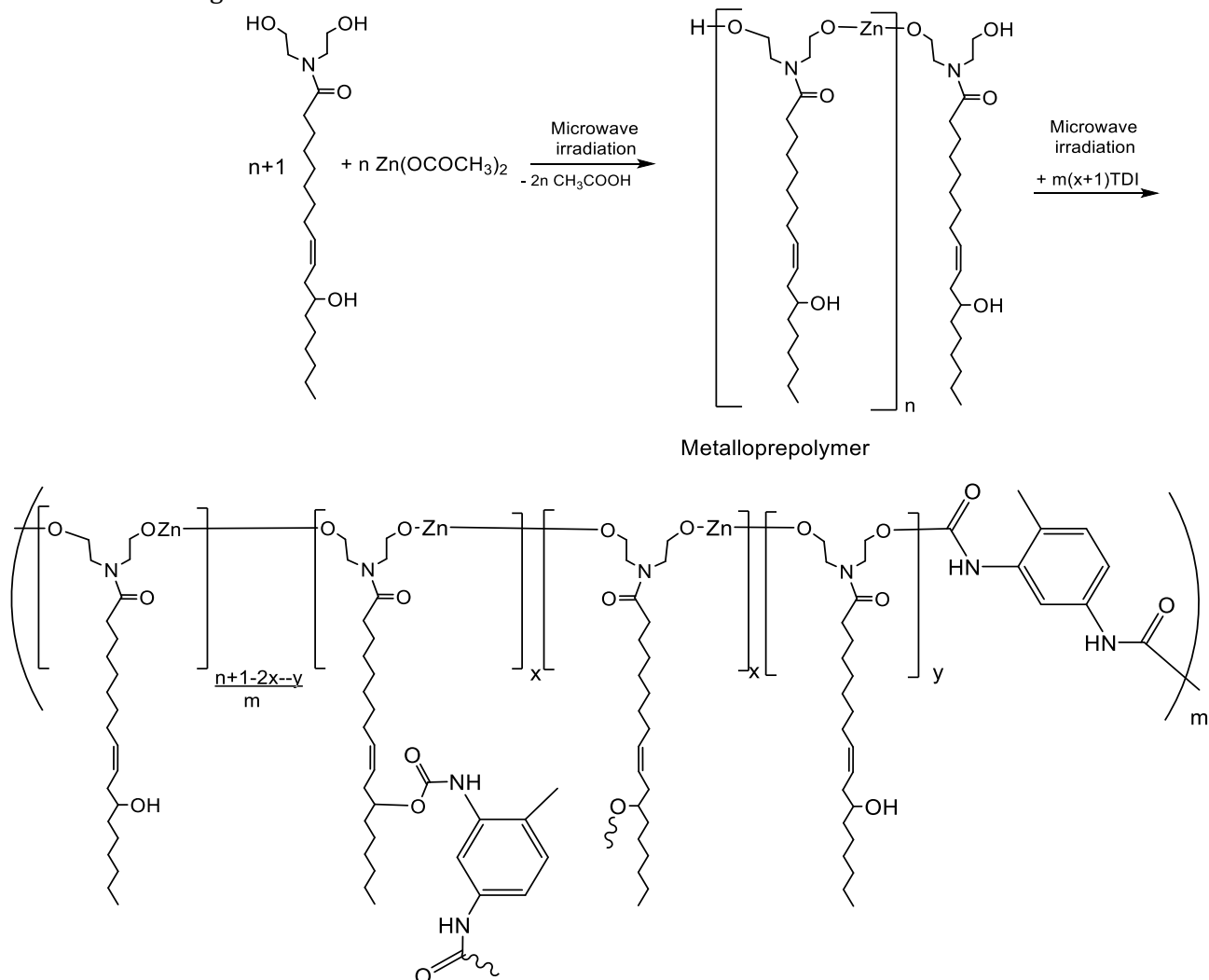

Fig. 25. Synthesis of Zn-PUA with using the microwave irradiation technique [63]

Incorporation of zinc into the structure of Mt-PUA was confirmed by its transparency and solubility in various solvents. Zinc acetate itself does not dissolve in EMK, xylene, or diethyl ether. At the same time, Zn-PUA resins have 100 % solubility in xylene, diethyl ether, DMSO, EMK and are insoluble in water. The formation of metal-containing polyurethanamide was also confirmed by the results of FT-IR spectroscopy and analyzing physical and chemical data.

The resulting Zn-PUA is cured at ambient temperature within 10–15 minutes without the use of any hardeners, and the coatings can be safely used as an anti-corrosion and environmentally friendly coating working at temperatures up to 200–220 °C. The authors claim

the beginning of industrial production of the studied materials.

It is known that the introduction of nanoparticles of ZnO, CuO, SiO₂, TiO₂ and others into the composition of plant-based polyurethane binders can improve the mechanical properties and corrosion resistance of coatings [64]. The use of TiO₂ as a filler provides coatings with antimicrobial and self-cleaning properties [65; 66].

An interesting approach is to obtain polyurethane-TiO₂ nanocomposite coatings based on sunflower oil diethanolamides [67]. TiO₂ nanoparticles were obtained using sol process from titanium isopropoxide according to the method described in [68].

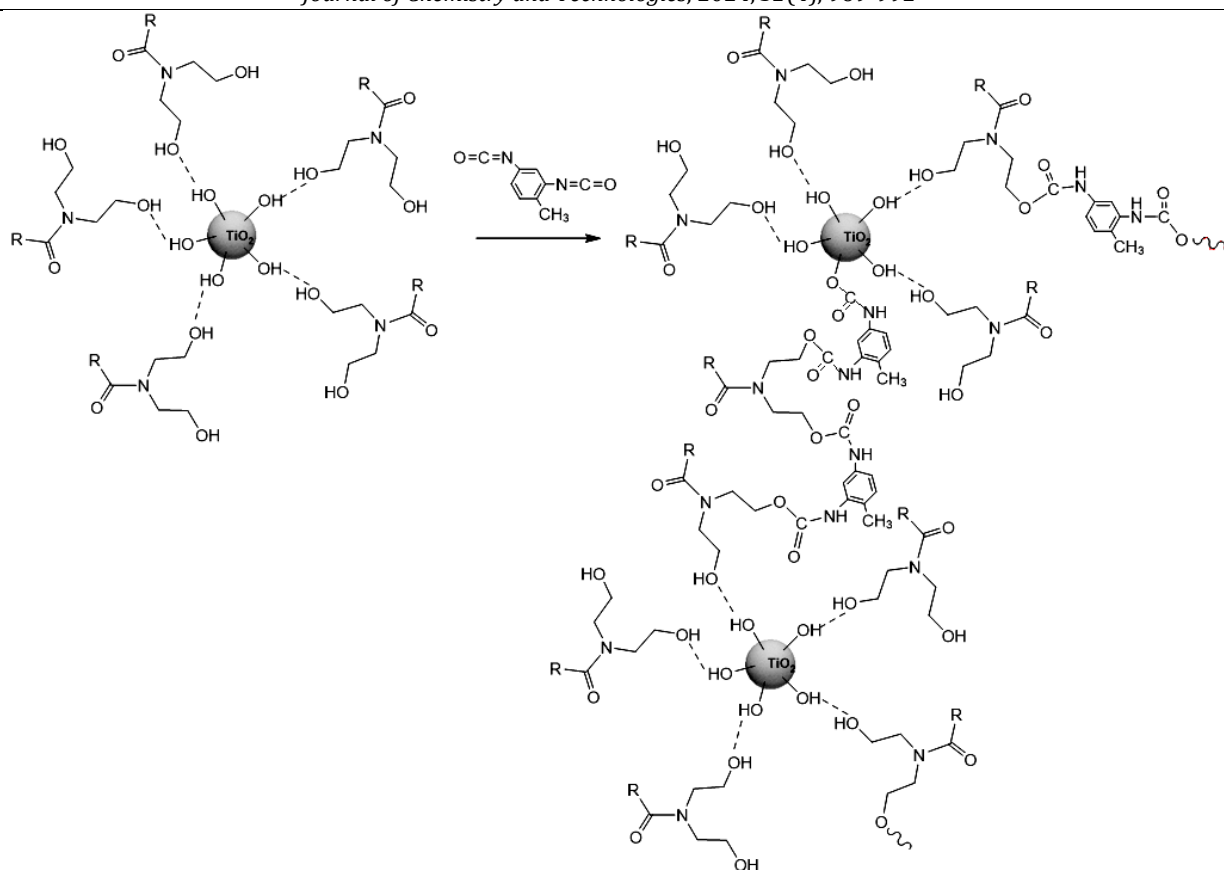

Fig. 26. Scheme synthesis and hypothetical structure of TiO_2 -PUA

The first stage of obtaining a binder included dispersing nano- TiO_2 (1, 2 and 3 wt. %) in diols of the diethanolamide sunflower oil with constant stirring at $80 \pm 5^\circ\text{C}$ under sonication until a clear solution was obtained. At the second stage, an 8-10% solution of TDI in dimethylformamide (DMF) was added to the resulting suspension (ratio of fatty acid diethanolamides:TDI = 1 : 1 w/w), after which the contents were heated while stirring for

another 30 minutes at $120 \pm 5^\circ\text{C}$. As can be seen from Fig. 26, TDI can react with the hydroxyl groups of both diethanolamide and filler to form polyurethanamide nanocomposite, which was confirmed by FT-IR and ^1H NMR spectroscopy. TEM microphotographs of the original TiO_2 nanoparticles and TiO_2 -PUA-3 composites (3% filler) are shown in Fig. 27 [67].

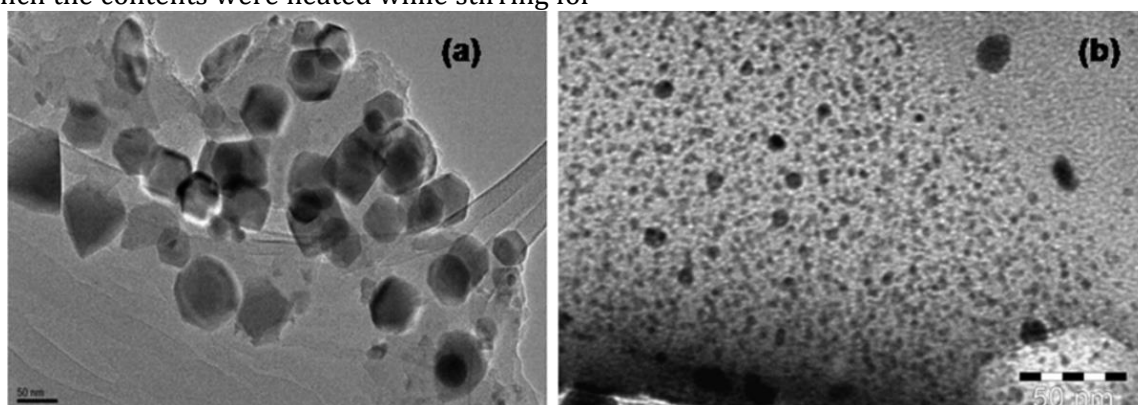

Fig. 27. TEM images of TiO_2 nanoparticle (a) and nanocomposite TiO_2 -PUA-3 (b)

Unmodified and modified PUA coatings were prepared at ambient temperature. The introduction of a nanofiller made it possible to reduce the drying time of coatings (dry-to-touch) from 30 to 25–15 minutes. Drying time decreased with increasing content of nano TiO_2 in the

composite. The coatings finally cured due to cross-linking (autoxidation) of unsaturated groups in remaining fatty acids of sunflower oil for another 5–6 days (final drying dry-to-hard).

The results of physical and mechanical tests of these coatings are presented in table 6 [67]. As can

be seen from the table, the hardness of nanocomposite coatings increases with the addition of up to 2 wt. % TiO₂ and then decreases.

With the addition of nano TiO₂, the adhesion and gloss of coatings also increases slightly.

Table 6

Physical and chemical properties of PUA и TiO₂-PUA nanocomposite

Properties/Code	PUA	TiO ₂ -PUA-1*	TiO ₂ -PUA-2*	TiO ₂ -PUA-3*
Dry-to touch (min)	30	25	20	15
Scratch Hardness (kg)	1.0	1.9	2.4	2.3
Cross cut adhesion (%)	95	100	100	100
Pencil hardness	1H	2H	3H	2H
Bend test (1/8 inch)	pass	pass	pass	pass
Gloss at 45°	82	84	84	86

*The numbers indicate the mass content of the filler in the nanocomposite

Thus, based on eco-friendly raw (sunflower-oil-derivative-based) can be obtained environmentally friendly anti-corrosion nanocomposite TiO₂-PUA film-forming systems, capable of forming thin, flexible, shiny, scratch-resistant coatings, thermally stable up to 275 °C and with good adhesion to low-carbon steel.

Conclusion

Based on the literature review, the prospects of carrying out work to find methods for the synthesis of alternative petrochemicals – diols, polyols and fatty acid diethanolamide derivatives obtained based on renewable raw materials – edible and inedible vegetable oils: soybean, sunflower, castor, flaxseed, cotton, etc., are shown.

Promising directions have been demonstrated for use of oleochemicals as monomers for production of biopolymers – polyurethanamides, polyesteramides, which are of undoubted interest as binders, polymer matrices, modifying additives for production of anti-corrosion coatings and polymer composite materials. Of particular interest is the possibility of obtaining metal-

containing polymers and nanocomposite materials that have an enhanced set of physical and mechanical characteristics, increased thermal stability and selective biological activity, which is regulated by the nature of the metal-containing compounds used in their synthesis.

Attractive is the possibility of regulating the properties (physical, mechanical, hydrophobic, ability to dry at ambient temperature, etc.) of the resulting materials by choosing the length of the alkyl chain of the fatty acid component, choosing the degree of its unsaturation, etc., i.e. special selection of fat-containing raw materials and technology for their processing into diols and polyether polyols of the desired structure.

Solving the above-mentioned questions will solve the problems of effective and comprehensive processing of renewable plant raw materials, developing methods of synthesis of biopolymer materials with the properties that equivalents or exceed for traditional petrochemical materials, but with a sharply reduced impact on the environment.

References

- [1] Karmakar, G., Dey, K., Ghosh, P., Sharma, B. K. Erhan, S. Z. (2021). Short Review on Polymeric Biomaterials as Additives for Lubricants. *Polymers*, 13(8), 1333. <https://doi.org/10.3390/polym13081333>
- [2] Siti Fatimah Abdul Halim, Siu Hua Chang, Norhashimah Morad (2019). Parametric studies of Cu(II) ion extraction into palm kernel fatty acid distillate as a green organic solvent. *Journal of Environmental Chemical Engineering*. 7(6), 103488. <https://doi.org/10.1016/j.jece.2019.103488>
- [3] Chang, S. H., Jampang, A. O. A. (2022). Green extraction of gold(III) and copper(II) from chloride media by palm kernel fatty acid distillate, *Journal of Water Process Engineering*. 47(June) 102646. <https://doi.org/10.1016/j.jwpe.2022.102646>
- [4] Patil, C. K., Jung, D. W., Jirimali, H. D., Baik, J. H., Gite, V. V., Hong, S. C. (2021). Nonedible Vegetable Oil-Based Polyols in Anticorrosive and Antimicrobial Polyurethane Coatings. *Polymers*, 13, 3149. <https://doi.org/10.3390/polym13183149>
- [5] Sharma, V., Kundu, P. P. (2008). Condensation polymers from natural oils. *Progress in Polymer Science*, 33, 1199–1215. <https://doi.org/10.1016/j.progpolymsci.2008.07.004>
- [6] Siyanbola, T.O. Neelambaram P., Mohanty, S., Somiseti, V., Basak, P., Ramanuj Narayan, Kothapalli, Raju V.S.N. (2019). The effects of carbonized Eucalyptus globulus leaves on castor seed oil based urethane coating system. *Progress in Organic Coatings*, 131, 42–48. <https://doi.org/10.1016/j.porgcoat.2019.02.018>
- [7] Deka, H., Karak, N. (2009). Vegetable Oil-Based Hyperbranched Thermosetting Polyurethane/Clay Nanocomposites. *Nanoscale Res Lett*, 4, 758–765. <https://doi.org/10.1007/s11671-009-9313-y>
- [8] Zhang, W., Wang, H., Chen, B., Bi, X., Venkatesan, S., Qiao, Q., Yang, Sh. (2012). Oleamide as a self-assembled cathode buffer layer for polymer solar cells: the role of the terminal group on the function of the surfactant. *J. Mater. Chem.*, 22, 24067. <https://doi.org/10.1039/c2jm35199d>
- [9] Palardy, O., Lieve, C. B., Laurens, M. L. (2017). Crude Hydrothermal Liquefaction Oils From Algal Biomass,

- Energy Fuels*, 31(8), 8275–8282. <https://doi.org/10.1021/acs.energyfuels.7b01175>
- [10] Abdelmoez, W., Mustafa, A. (2014). Oleochemical industry future through biotechnology. *Oleo Sci.*, 63(6), 545–54. <https://doi.org/10.5650/jos.ess14022>
- [11] Holmiere, S., Valentin, R., Maréchal, P., Mouloungui, Z. (2017). Esters of oligo-(glycerol carbonateglycerol): new biobased oligomeric surfactants. *J. of Colloid and Interface Science*, 487, 418–425. <https://doi.org/10.1016/j.jcis.2016.10.072>
- [12] Alam, M., Akram, D., Sharmin, E., Zafar, F., Ahmad, Sh. (2014). Vegetable oil based eco-friendly coating materials: A review article. *Arabian Journal of Chemistry*, 7(4), 469–479. <https://doi.org/10.1016/j.arabjc.2013.12.023>
- [13] Cheng, T. (2019). Review of novel energetic polymers and binders – high energy propellant ingredients for the new space race. *Designed Monomers and Polymers*, 22(1), 54–65. <https://doi.org/10.1080/15685551.2019.1575652>
- [14] Szala, M. (2021). Polymer-bonded secondary explosives (Kruszące materiały wybuchowe z lepiszczem polimerowym). *Materiały Wysokoenergetyczne. High Energy Materials*, 13(5), 16. https://doi.org/10.22211/matwys/0213ISSN_2083-0165
- [15] Song, H., Chai, W., Yang, F., Ren, M., Chen, F., Guan, W., Zhang, Sh. (2021). Effects of Dietary Monoglyceride and Diglyceride Supplementation on the Performance, Milk Composition, and Immune Status of Sows During Late Gestation and Lactation. *Front Vet. Sci.*, 8, 714068. <https://doi.org/10.3389/fvets.2021.714068>
- [16] Suhane, A., Rehman, A., Khaira, H. (2012). Potential of non-edible vegetable oils as an alternative lubricants in automotive applications. *Int. J. Eng. Res Appl.*, 2, 1330–1335.
- [17] Attia, M. I., Zoorob, S., Hassan, K., El-husseini H., Reid, J. M., Al Kuwari, M. S. (2017). Development of building blocks using vegetable oil and recycled aggregate. *MATEC Web of Conf.* 12, 03006. <https://doi.org/10.1051/mateconf/201712003006>
- [18] Forth, J.P., Zoorob, S. (2008). Vegetable oil-based construction materials. (2008) *International Patent No WO 2008/117077 (A3)*.
- [19] Alam, M., Akram, D., Sharmin, E., Zafar, F., Ahmad, S. (2014). Vegetable oil based eco-friendly coating materials: a review article. *Arab. J. Chem.*, 7(4), 469–479. <https://doi.org/10.1016/j.arabjc.2013.12.023>
- [20] Hosney, H., Nadiem, B., Ashour, I., Mustafa, I., El-Shibiny, A. (2018). Epoxidized vegetable oil and bio-based materials as PVC plasticizer. *J. Appl. Polym. Sci.*, 135(20), 46270. <https://doi.org/10.1002/APP.46270>
- [21] Chen, J., Li, X., Wang, Y., Ke Li, Y-H., Nie, X., Jiang, J. (2017). Synthesis and application of environmental soybean oil-based epoxidized glycidyl ester plasticizer for poly(vinyl chloride). *European Journal of Lipid Science and technology*, 119(5), 1600216. <https://doi.org/10.1002/ejlt.201600216>
- [22] Chandrashekhar, K. P., Dong, W. J., Harishchandra, D. Jirimali, J. H. B., Vikas, V. G., Hong, S.C. (2021). Nonedible vegetable oil-based polyols in anticorrosive and antimicrobial polyurethane coatings. *Polymers*, 13(18), 3149. <https://doi.org/10.3390/polym13183149>
- [23] Behr, A., Seidensticker, T. (2020). The basics of oleochemistry-basic oleochemicals. In *Chemistry of renewables*. Springer, Berlin, Heidelberg. https://doi.org/10.1007/978-3-662-61430-3_3. 37-60
- [24] Chervakov, O. V., Filinskaya, T. G., Kopiton, V. O. (2007). [Methods of transesterification of fat-containing raw materials by alcoholysis]. *Voprosy khimii i khimicheskoi technologii*, (4), 72–79 (In russian).
- [25] Filinska T. G., Chervakov, O. V. (2010). [Transesterification of vegetable and animal fats by the alcoholysis method using an alkaline and acid catalyst]. *Voprosy khimii i khimicheskoi technologii*, (2), 34–38 (In Ukrainian).
- [26] Filinskaya, T. G. Chervakov, O. V. Gerasimenko, K. O., Tanko, J. Yu. (2013). [Application of new heterogeneous sulfonic acid polymer catalysts in the processing of waste from fat processing industries] *Kataliz v promy`shlennosti*, (3), 75–81 (In russian).
- [27] Paulo, A. Z. Suarez, S. M., Plentz Meneghetti, M. R. Carlos, M., Wolf, R. (2007). Transformação de triglicerídeos em combustíveis, materiais poliméricos e insumos químicos: algumas aplicações da catálise na oleoquímica [Transformation of triglycerides into fuels, polymers and chemicals: Some applications of catalysis in oleochemistry]. *Quim. Nova*, 30(3), 667–676.
- [28] Pattabiraman, Vijaya R., Bode, Jeffrey W. (2011). Rethinking amide bond synthesis *Nature*, 480(7378), 471–479. [doi:10.1038/nature10702](https://doi.org/10.1038/nature10702).
- [29] Farrell, E. K., Merkler, D. J. (2008). Biosynthesis, degradation and pharmacological importance of the fatty acid amides. *Drug Discovery Today*, 13(13-14), 558–68. <https://doi.org/10.1016/j.drudis.2008.02.006>
- [30] de Oliveira, F. R., Rodrigues, K. E., Hamoy, M., Sarquis, Í. R., Hamoy, A. O., Lopez, M. E. C., Ferreira, I. M., de Matos, Macchi, B., do Nascimento, J. L. M. (2020). Fatty acid amides synthesized from Andiroba oil (*Carapa guianensis Aublet.*) exhibit anticonvulsant action with modulation on gaba-a receptor in mice: a putative therapeutic option. *Pharmaceuticals*, 13(3), 43. <https://doi.org/10.3390/ph13030043>
- [31] Ni, R., Bhandari, S., Perry, R., Jr. M., Suarez, G., Neel, B. P., Kirpal, S. K. L., Bisht, D., Merkler, J. (2021). Synthesis, quantification, and characterization of fatty acid amides from in vitro and in vivo sources. *Molecules*, 26(9), 2543. <https://doi.org/10.3390/molecules26092543>
- [32] Melnyk, S., Danyliuk, R., Melnyk, Yu., Reutskyy, V. (2018). The reaction of oleic acid with a mixture of ethanolamines. *Chem. Chem. Technol.*, 12(1), 13–17. <https://doi.org/10.23939/chcht12.01.013>
- [33] Fábio Rodrigues de Oliveira, Nágila Monteiro da Silva, Moisés Hamoy, Maria Elena Crespo-López, Irlon Maciel Ferreira, Edilene Oliveira da Silva, Barbarella de Matos Macchi, José Luiz Martins do Nascimento. (2022). The GABAergic system and endocannabinoids in epilepsy and seizures: what can we expect from plant oils? *Molecules*, 27(11), 3595. <https://doi.org/10.3390/molecules27113595>
- [34] Porcayo-Calderon, J., Rivera-Muñoz, E. M., Peza-Ledesma, C., Casales-Diaz, M., Martínez de la Escalera, L. M., Canto, J., Martinez-Gomez, L. (2017). Sustainable development of palm oil: synthesis and electrochemical performance of corrosion inhibitors. *J. Electrochem. Sci. Technol.*, 8(2), 133–145. <https://doi.org/10.5229/JECST.2017.8.2.133>
- [35] Kumar, D., Park, C.H., Kim, C.S. (2020). Sustainable heterogeneously catalyzed single-step and two-step amide derivatives of non-edible natural triglycerides as dual-functional diesel fuel additives. *Industrial Crops and Products*, 158(15), 113001. <https://doi.org/10.1016/j.indcrop.2020.113001>

- [36] Kashif, M., Sharmin, E., Zafar, F., Ahmad, Sh. (2011). Synthesis and characterization of ricinoleamide-based polyurethane. *J. Am. Oil. Chem. Soc.* 88(12), 1989–1996. <https://doi.org/10.1007/s11746-011-1867-z>.
- [37] Mutlu, H., Meier, M. A. R. (2010). Castor oil as a renewable resource for the chemical industry. *Eur. J. Lipid. Sci. Technol.* 112(1), 10–30. <https://doi.org/10.1002/ejlt.200900138>.
- [38] Pandya, H., Mahanwar, P. (2020). Fundamental insight into anionic aqueous polyurethane dispersions. *Advanced Industrial and Engineering Polymer Research*, 3(3), 102–110. <https://doi.org/10.1016/j.aiepr.2020.07.003>.
- [39] Meshrama, P. D., Puria, R. G., Patil, A. L., Giteb., V. V. (2013). Synthesis and characterization of modified cottonseed oil based polyesteramide for coating applications. *Progress in Organic Coatings*, 76(9), 1144–1150. <http://dx.doi.org/10.1016/j.porgcoat.2013.03.014>
- [40] John Argyropoulos, Paul Popa, Gary Spilman, Debkumar Bhattacharjee, William Koonce. (2009). Seed oil based polyester polyols for coatings. *J. Coat. Technol. Res.*, 6(4), 501–508. <https://doi.org/10.1007/s11998-008-9154-0>
- [41] Kaur, R., Singh, P., Tanwar, S., Varshney, G., Yadav, S. (2022). Assessment of bio-based polyurethanes: perspective on applications and bio-degradation. *Macromol.*, 2(3), 284–314. <https://doi.org/10.3390/macromol2030019>
- [42] Lysenko, Z., Schrock, A. K., Babb, D. A., Sanders, A. (2004). Vegetable oil based polyols and polyurethanes made therefrom. (2004). *International Patent WO2004096882 (A1)*.
- [43] Hoy, K. L. (1970). New values of the solubility parameters from vapor pressure data. *J. Paint Techn.*, 42(541), 76–78.
- [44] Hoy, K. L. (1985). The Hoy Tables of solubility parameters. *Union Carbide Corp., South Charleston, WV*
- [45] Guner, A. (2004). The algorithmic calculations of solubility parameter for the determination of interactions in dextrin/certain polar solvent systems. *Eur. Polym. J.*, 40, 1587–1594.
- [46] Dipak, S. Tathe, Jagtap, R. N. (2014). Design novel polyhydroxyl fatty amide based on Balanites roxburgii oil and its application for coating. *Designed Monomers and Polymers*, 17(8), 717–725. <http://dx.doi.org/10.1080/15685551.2014.907622>.
- [47] Campanella, A., Baltanas, M. A. (2010). Degradation of the oxirane ring of epoxidized vegetable oils in liquid-liquid systems. I. Hydrolysis and attack by H₂O₂. *Lat. Am. Appl. Res.*, 35, 205–210.
- [48] Sugita, H. P., Mas'ud, Z. A. (2012). Synthesis and application of jatropha oil based polyurethane a,s paint coating material. *Makara Journal of Science*, 16(2), 134–140. <https://doi.org/10.7454/mss.v16i2.1409>
- [49] Ahmad, S., Ashraf, S. M., Zafar, F. (2007). Development of linseed oil based polyesteramide without organic solvent at lower temperature. *J. Appl. Polym. Sci.* 104(2), 1143–1148. <https://doi.org/10.1002/app.25774>
- [50] Ahmad, S., Ashraf, S. M., Sharmin, E., Alam, M. (2005) Ambient cured tartaric acid modified oil fatty amide anticorrosive coatings. *J. Macromol. Sci. A Pure Appl. Chem.*, 42(6) 751–764. <https://doi.org/10.1081/MA-200058648>
- [51] Ahmad, S., Ashraf, S. M., Alam, M. (2006). Studies on melamine modified polyesteramide as anticorrosive coatings from linseed oil. A sustainable resource. *J. Macromol. Sci. A Pure Appl. Chem.* 43(4-5), 773–783. <https://doi.org/10.1080/10601320600598886>
- [52] Yadav, S.; Zafar, F., Hasnat, A., Ahmad, S. (2009). Poly (Urethane Fatty Amide) Resin from Linseed Oil – a Renewable Resource. *Prog. Org. Coat.*, 64(1), 27–32. <https://doi.org/10.1016/j.porgcoat.2008.07.006>
- [53] Toliwal, S. D., Patel, K. (2006). Modified neem (Azadirachta indica) oil based curing of acid functional acrylic copolymer resin for anticorrosive coating. *J. Sci. Ind. Res.*, 65, 590–593.
- [54] Zafar, F., Zafar, H., Sharmin, E., Ashraf, S. M., Ahmad, S. (2011). Studies on ambient cured biobased Mn(II), Co(II) and Cu(II) containing metallopolyesteramides. *J. Inorg. Organomet. Polym. and Mater.*, (3), 646–654. <https://doi.com/10.1007/s10904-011-9512-8>
- [55] Zafar, F., Ashraf, S. M., Ahmad, S. (2007)/ Cd and Zn-incorporated polyesteramide coating materials from seed oil – A renewable resource. *Progress in Organic Coatings*, 59(1), 68–75. <https://doi.org/10.1016/j.porgcoat.2007.01.009>
- [56] Zafar, F., Hassan, Mir M., Kashif, M., Sharmin, E., Ahmad, S. (2013). Microwave Assisted Synthesis of Bio Based Metallopolyurethaneamide. *J. Inorg. Organomet. Polym. And Mater.*, 21, 61–68. <https://doi.org/10.1007/s10904-010-9420-3>
- [57] Meshrama, P. D., Puri, R. G., Patil, A. L., Gite, V. V. (2013). Synthesis and characterization of modified cottonseed oil based polyesteramide for coating applications. *Progress in Organic Coatings*, 76(9), 1144–1150. <https://doi.org/10.1016/j.porgcoat.2013.03.014>
- [58] Patil, Ch. K., Jung, D. W., Jirimali, H. D., Baik, J. H., Gite, V. V. Hong, S. Ch. (2021). Nonedible vegetable oil-based polyols in anticorrosive and antimicrobial polyurethane. *Coatings Polym.*, 13(18), 3149. <https://doi.org/10.3390/polym13183149>
- [59] Zafar, F., Ashraf, S. M., Ahmad, S. (2007). Studies on zincontaining linseed oil based polyesteramide. *Reactive & Functional Polymers*, 67(10), 928–935. <https://doi.org/10.1016/j.reactfunctpolym.2007.05.018>
- [60] Zafar, F., Ashraf, S. M., Ahmad, S. (2007)/ Cd and Zn-incorporated polyesteramide coating materials from seed oil – a renewable resource. *Progress in Organic Coatings*, 59(1), 68–75. <https://doi.org/10.1016/j.porgcoat.2007.01.009>
- [61] Bharathi, P., Nazia Umar Khan, Manawwer Alam, Sheikh Shreaz, Athar Adil Hashmi. (2010). Cadmium incorporated oil based bioactive polymers: synthesis, characterization and physico-chemical studies. *J. Inorg. Organomet. Polym. and Mater.*, 20, 833–838. <https://doi.org/10.1007/s10904-010-9362-9>
- [62] Samui, A. B., Chavan, J. G., Hande, V. R. (2006). Study on film forming organo-copper polymer. *Progress in Organic Coatings*, 57, 301–306. <https://doi.org/10.1016/j.porgcoat.2006.09.020>
- [63] Fahmina, Z., Mir, M. H., Kashif, M., Sharmin, E., Ahmad, S. (2011). Microwave assisted synthesis of bio based metallopolyurethaneamide. *J. Inorg. Organomet. Polym. And Mater.*, 21, 61–68. <https://doi.org/10.1007/s10904-010-9420-3>
- [64] Rahman, O. U., Ahmad, S. (2016). Soy polyester urethane/TiO₂ and Ce-TiO₂ nanocomposites: preparation, characterization and evaluation of electrochemical corrosion resistance performance. *RSC Adv.*, 6, 10584–10596. <https://doi.org/10.1039/C5RA23928A>

- [65] Charpentier, P., Burgess, K., Wang, L., Chowdhury, R., Lotus, A., Moula, G. (2012). Nano-TiO₂/polyurethane composites for antibacterial and self-cleaning coatings. *Nanotechnology*, 23(42), 425606. 17-23. <https://doi.org/10.1088/0957-4484/23/42/425606>
- [66] Diez-Pascual, A. M., Diez-Vicente, A. L. (2015). Development of linseed oil-TiO₂ green nanocomposites as antimicrobial coatings. *J. Mater. Chem. B*, (21), 4458-4471. <https://doi.org/10.1039/c5tb00209e>
- [67] Alam, M., Alandis, N. M., Zafar, F., Eram Sharmin, Yasser, M. Al-Mohammadi. (2018). Polyurethane-TiO₂ nanocomposite coatings from sunflower oil-based amide diol as soft segment. *J. of Macromol. Sci, Part A*, 55(10), 698-708. <https://doi.org/10.1080/10601325.2018.1526638>
- [68] Shaik, M. R.; Alam, M.; Alandis, N. M. (2015)/ Development of castor oil based poly(urethane-esteramide)/TiO₂ nanocomposites as anticorrosive and antimicrobial coatings. *Journal of Nanomaterials*, 2015, 745217. <http://dx.doi.org/10.1155/2015/745217>